

NeoDen K1830

High Speed Pick and Place Machine

User Manual



Model: ..K1830 High Speed Pick and Place Machine.....

Version: ..V3.0.....

1. Preface

Dear users: sincerely thank you for your kindly support to our NeoDen. Before operating this equipment, please read this manual and understand its contents. Please keep this manual close to the equipment for reference when needed.

Persons who have not been trained on this equipment should not use this equipment.

Please turn off the power switch when inspecting the equipment, replacing or repairing parts, and performing internal settings.

The repair and maintenance work not mentioned in this manual should be carried out by the maintenance engineer recognized by the company. Customers are not allowed to perform this operation based on their own judgment, otherwise accidents may result.

It is forbidden for two or more people to operate the same machine at the same time, and it is strictly forbidden for someone to operate while putting their head or hands into the machine.

The safety pin of the machine equipment is safe and effective. It is forbidden to remove the safety pin from the safety door and insert it directly into the machine to open the door.

Removal of anti-rust protective film

In order to prevent the equipment from rusting due to environmental impact during transportation, we pasted a protective film on the following parts of the machine as protection. This protective film needs to be removed manually before the equipment is powered on. If there is any omission, there will be hidden danger of poor operation and the possibility of damage.

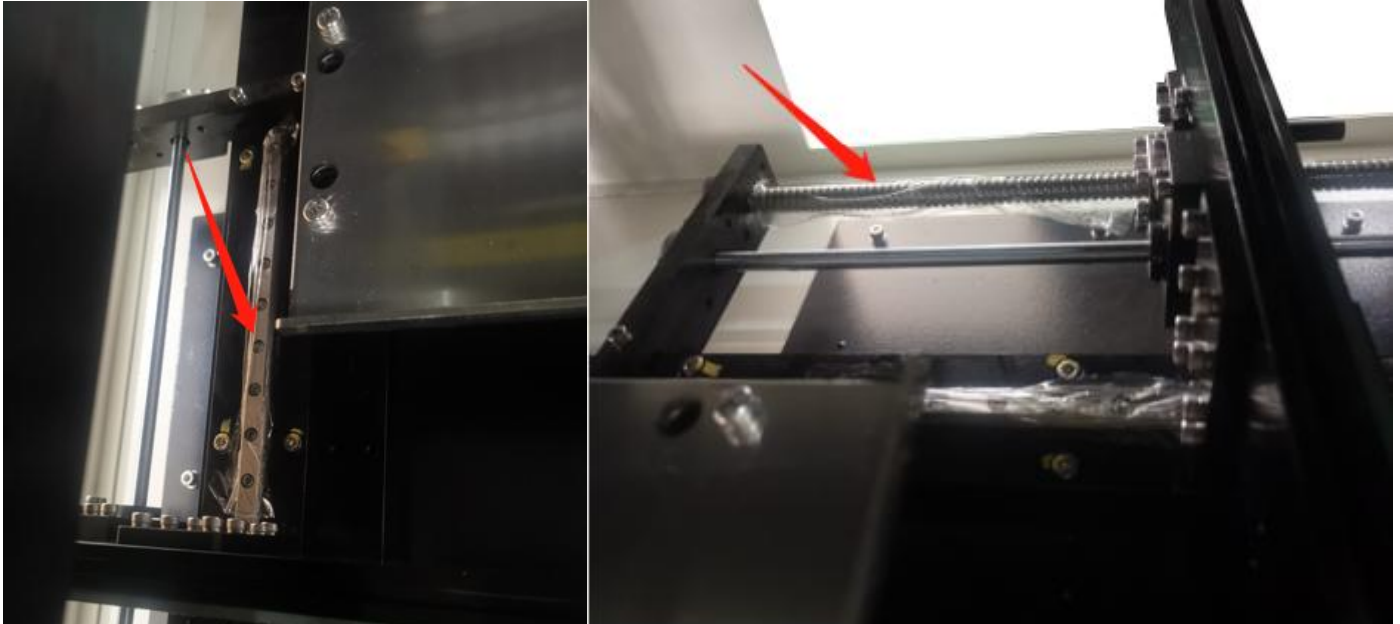


Fig A: Anti-rust protective film

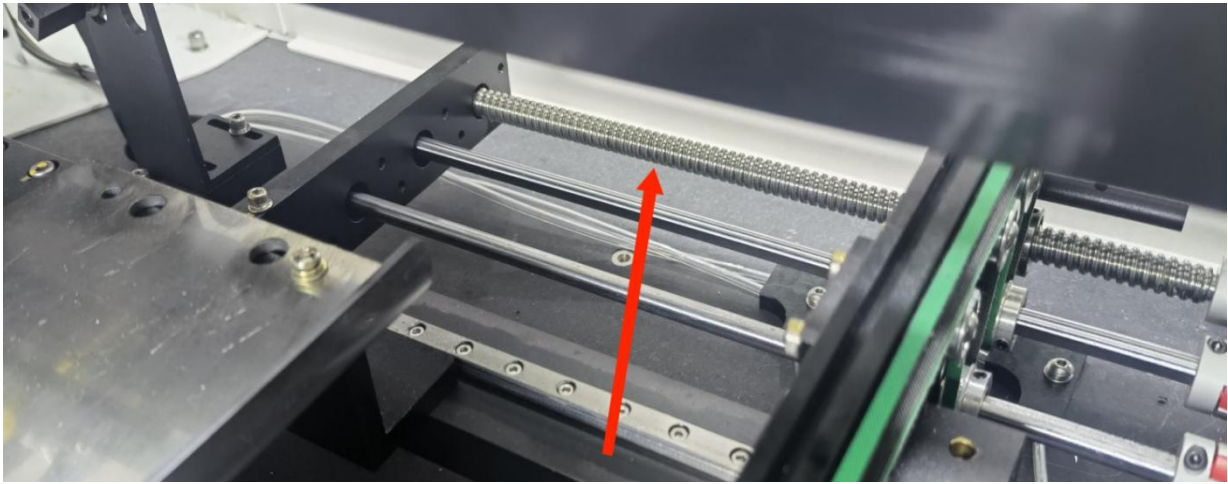


Fig B: screw ball of track left and right movement

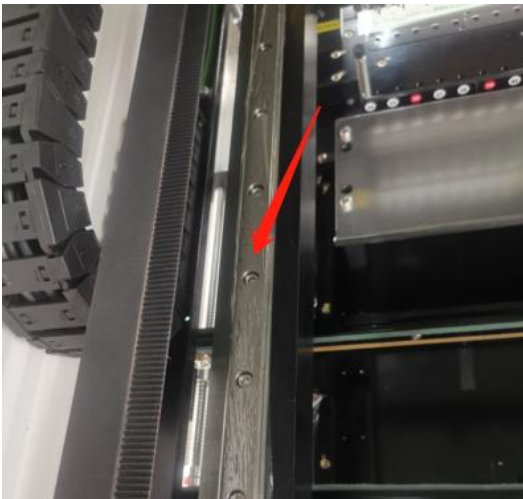


Fig C: linear rail of Y-axis left and right movement

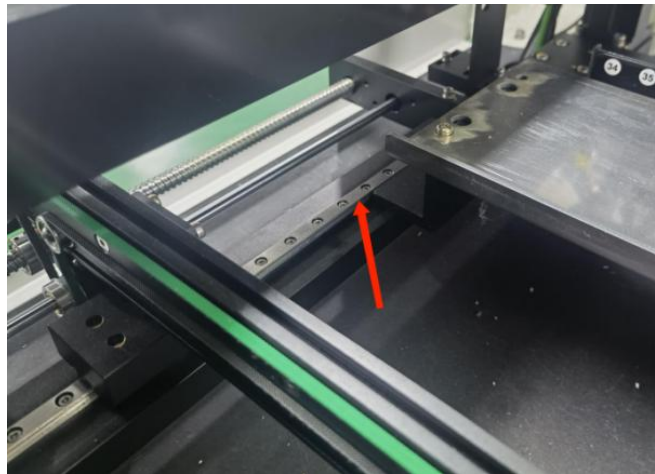


Fig D: linear rail of the track left and right movement

Important Notice



Warning of failure risk of camera identification, please referring to Figure 2 and Figure 3:

The following parts are forbidden to touch and impact

- ◆ Front IC Camera
- ❖ Back IC camera
- ◆ Left Fiducial camera
- Right fiducial camera



Warning of accuracy failure risk, refer to Figure 3: The following components are prohibited from touching and impacting.

- ◆ Return to zero column

For the risk of accuracy failure, refer to Figure4: When manually moving XY, it must be carried out on the X-axis beam moving point;



Warning of electric shock, be sure to follow the requirements below:

- ◆ Connect the input power supply that meets the requirements of the equipment, the electrical interface of the machine to the ground must be effectively grounded;
- ❖ Any time you enter the case and stick to the head for maintenance, you need to shut down the machine properly and cut off the power supply;



Warning of equipment life reduction, be sure to follow the requirements below:

- ◆ When installing the equipment, the equipment must be leveled;
- ❖ Correct shutdown: shut down the operating software and the system before turning off the



Fig E-Oily water separator two-piece

The air source connection of the equipment is not less than 0.6MP

Note: When adjusting the pressure, please pull up and then rotate the knob before turning it, and press down the knob for positioning. When adjusting the pressure, it should be adjusted to the required pressure value gradually and evenly, and should not be adjusted in one step.



Fig F- Feeder air pressure value pressure 0.55MP

Note: When adjusting the pressure, please pull up and then rotate the knob before turning it, and press down the knob for positioning. When adjusting the pressure, it should be adjusted to the required pressure value gradually and evenly, and should not be adjusted in one step.

The air source access is not lower than 0.6MP.

Note: When the pressure is input at 0.6MPA, the air flow is 37L/min, and it is recommended to use a compressed air storage tank of not less than 70L



Fig G- Air switch

First, after the power cord of the device is connected to the correct power supply, push up the blue handle of the air switch, at this time the indicator light of the air switch will turn red, and then turn the power switch on the front of the device to start it.

Note: The air switch is also an air circuit breaker, which can reliably protect the circuit. The circuit breaker on the machine is closed by default. If a trip occurs, try to close it when the external power supply voltage is normal. If the trip still occurs after many attempts, please contact the manufacturer's after-sales service in time.

CONTENTS

1. Preface.....	2
2. Machine Overview	9
2.1 Machine Dimension	9
2.2 Working Area Structure	9
2.3 Machine Structure	12
2.4 Operation Flow Chart	13
2.5 File Programming Process	15
3. File List	16
4. PCB Information	17
4.1 PCB Forward Setting	17
4.2 PCB Backward Setting	19
4.3 Safe Height	19
4.4 Track Speed	19
4.5 Hole Length	19
5. Coordinate Information	20
5.1 PCB Fiducial Setting	20
5.2 Component List Setting	22
5.2.1 Manual Programming	22
5.2.2 File Import Programming	23
5.2.3 Other Functional Buttons	23
5.3 Auto Programming	28
6. Panelized Board Information	32
6.1 SMD 1 Position Setting	32
6.2 Create Panelized List	32
7. Feeder Information	36
7.1 Feeder Basic Information	36
7.2 Feeder Settings	37
8. Nozzle Information	43
9. Mounting Interface	44
9.1 Mounting Interface Introduction	44
9.2 Configuration Introduction	47
10. Manual Test	48
10.1 Basic Information	48
10.2 XY Position Lock Interface	49
11. System Setup	51
11.1 Feeder Position Config	51
11.2 Component Positions Setup	53
11.3 Basic Configuration	53
12. First Trial and Test	56
12.1 First Trial	57
12.2 Inspection Standard	58
12.3 Continuous SMT production	58
13. Structure and Maintenance Instruction	60
13.1 Feeder Brief Introduction	60

13.2 Installing Tape and Reel Components	61
13.3 Incorrect Installation Samples	62
13.4 Nozzle Information	64
14. Maintenance	65
14.1 Routine Maintenance	65
14.2 Routine Inspection	66
14.3 Related Issues During Solder Paste Printing Process	67

2. Machine Overview

2.1 Machine Dimension

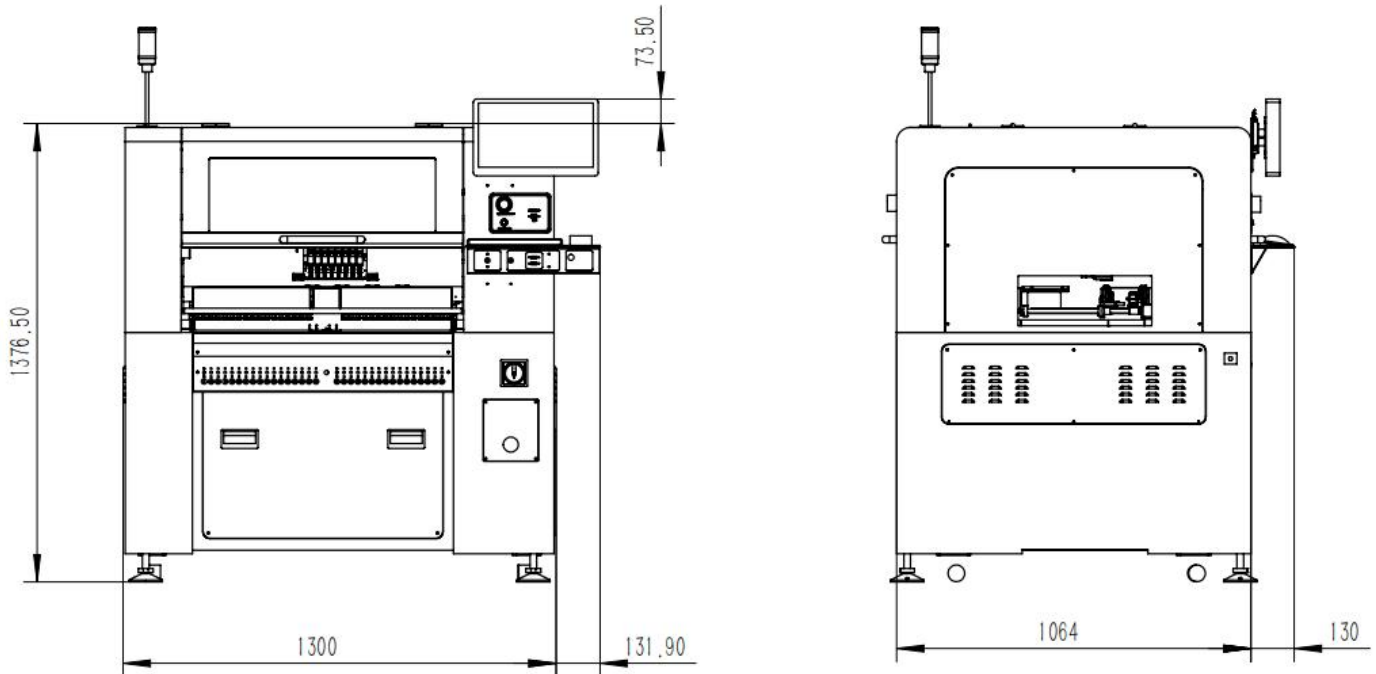


Fig1- Machine dimension

2.2 Working Area Structure

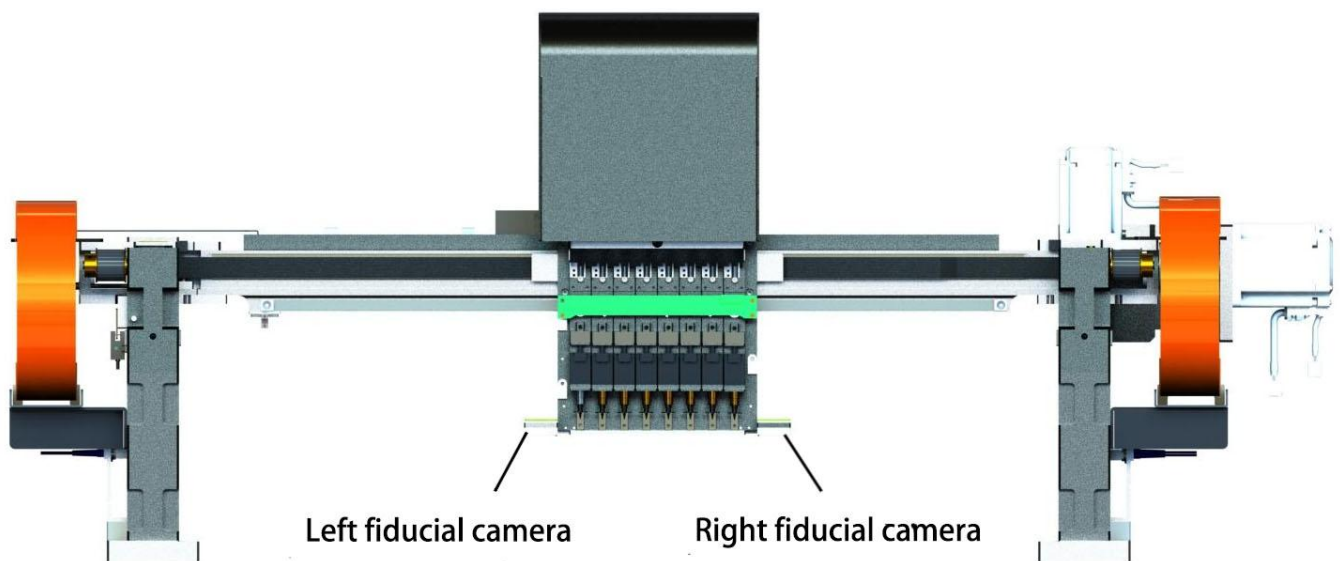


Fig 2: cameras on the placement head

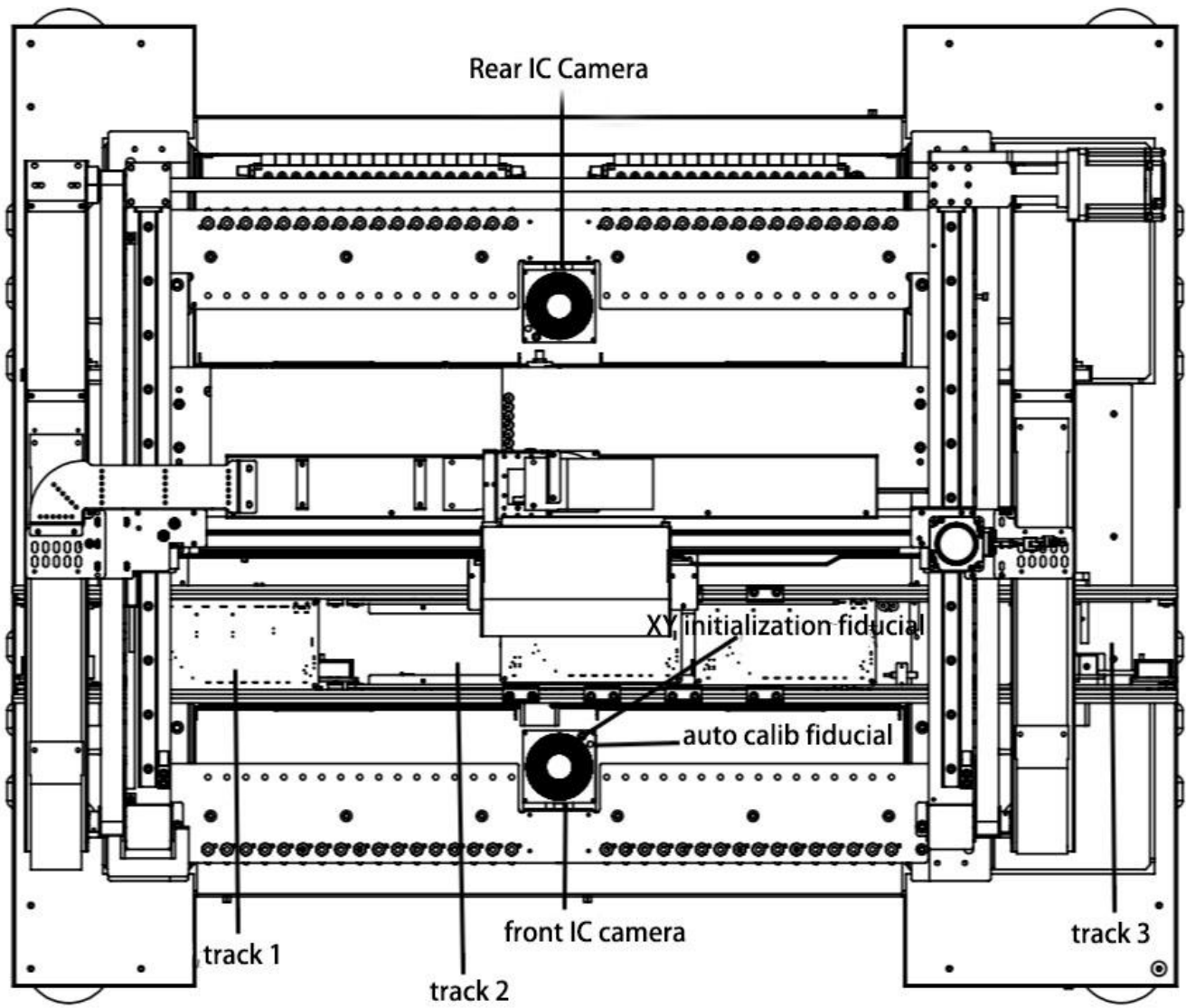


Figure 3- Top view of main working area

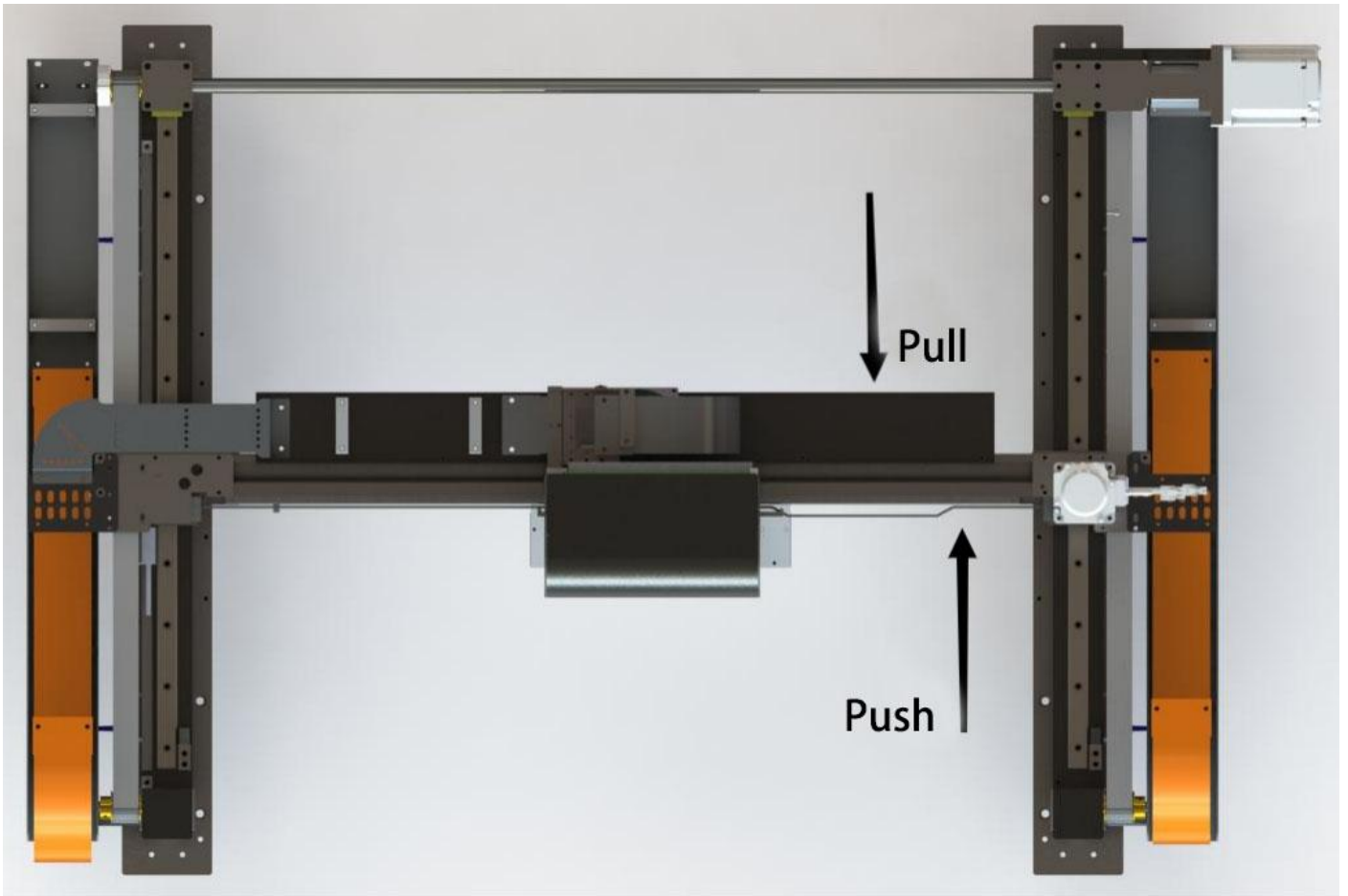


Figure 4-X-axis Beam

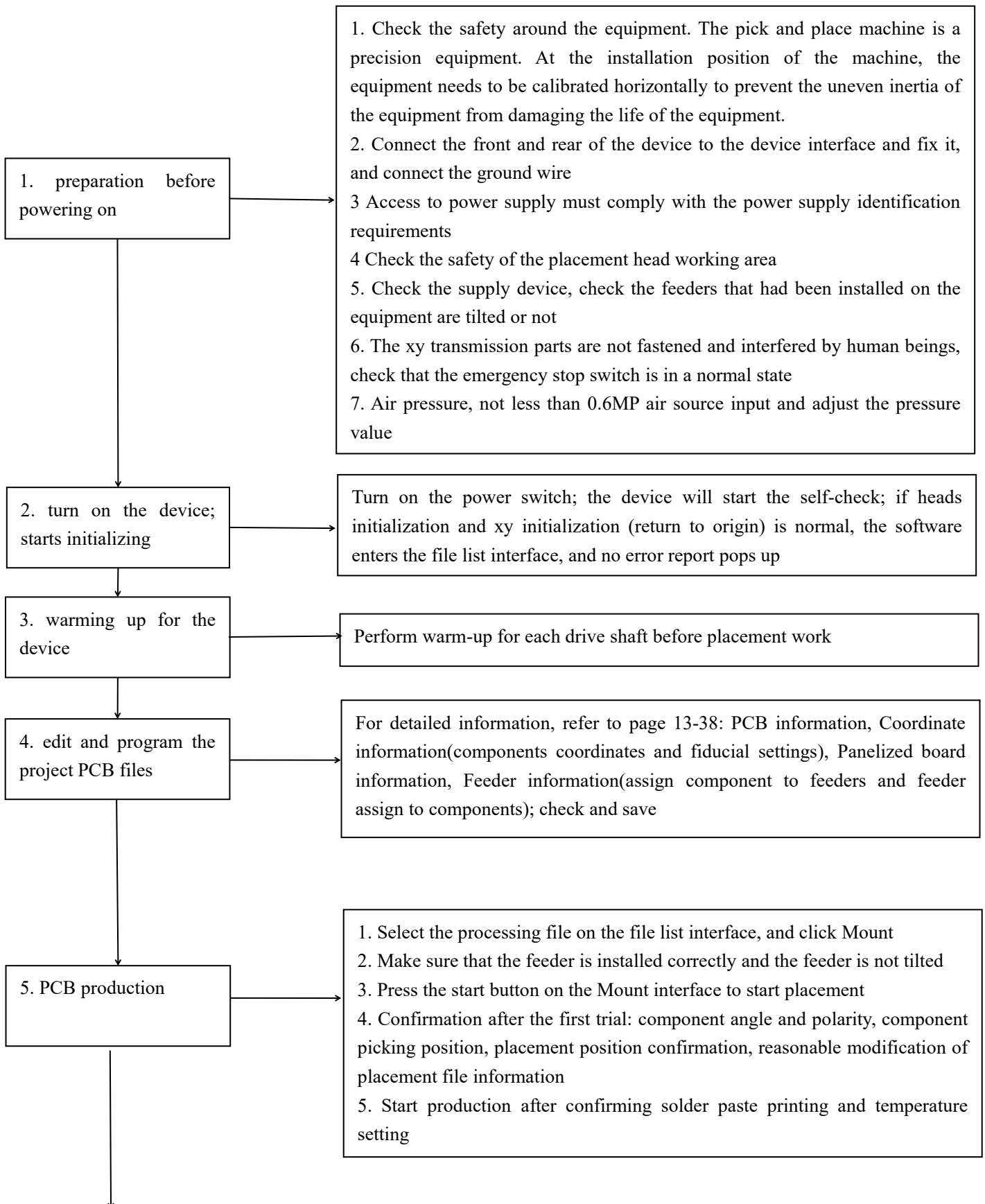
2.3 Machine Structure

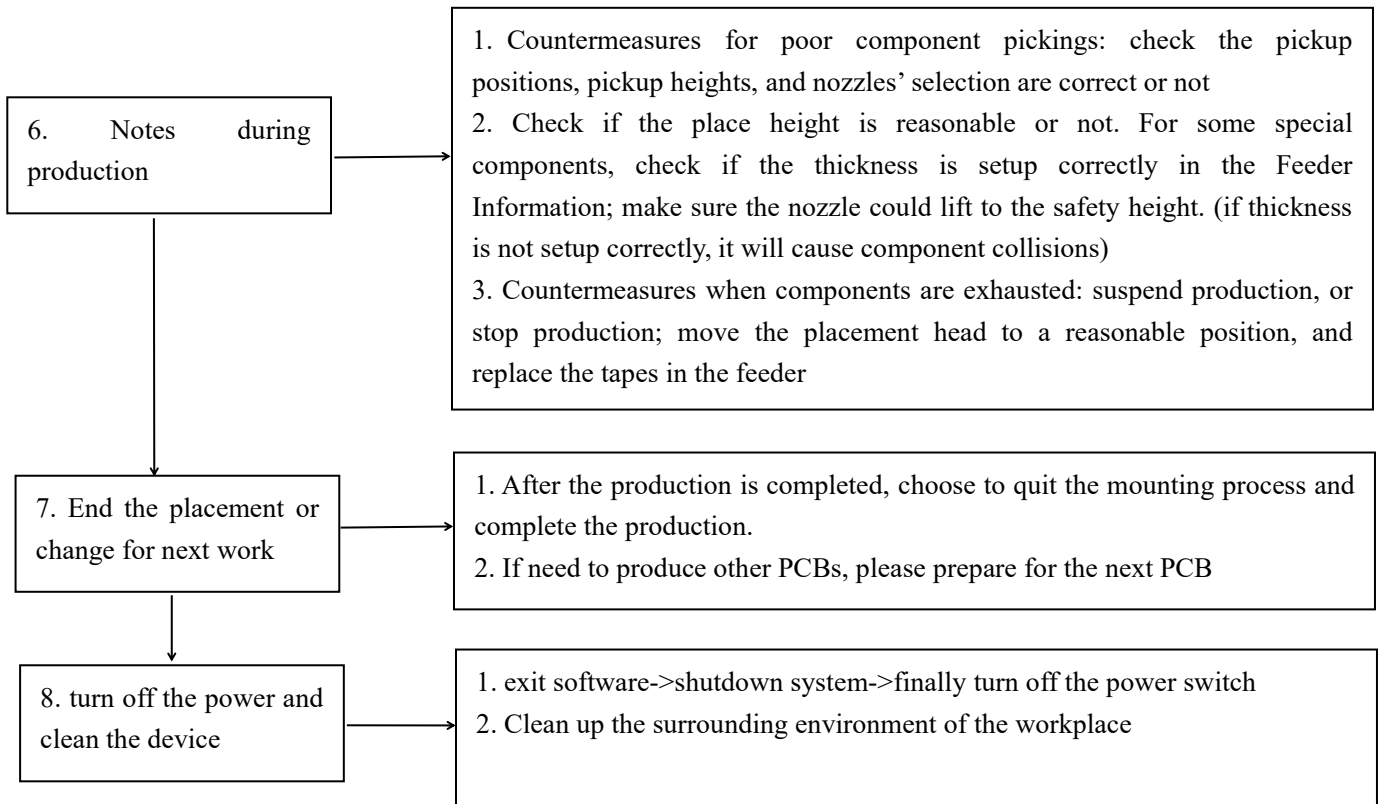


Fig 5- ports and and Appearance

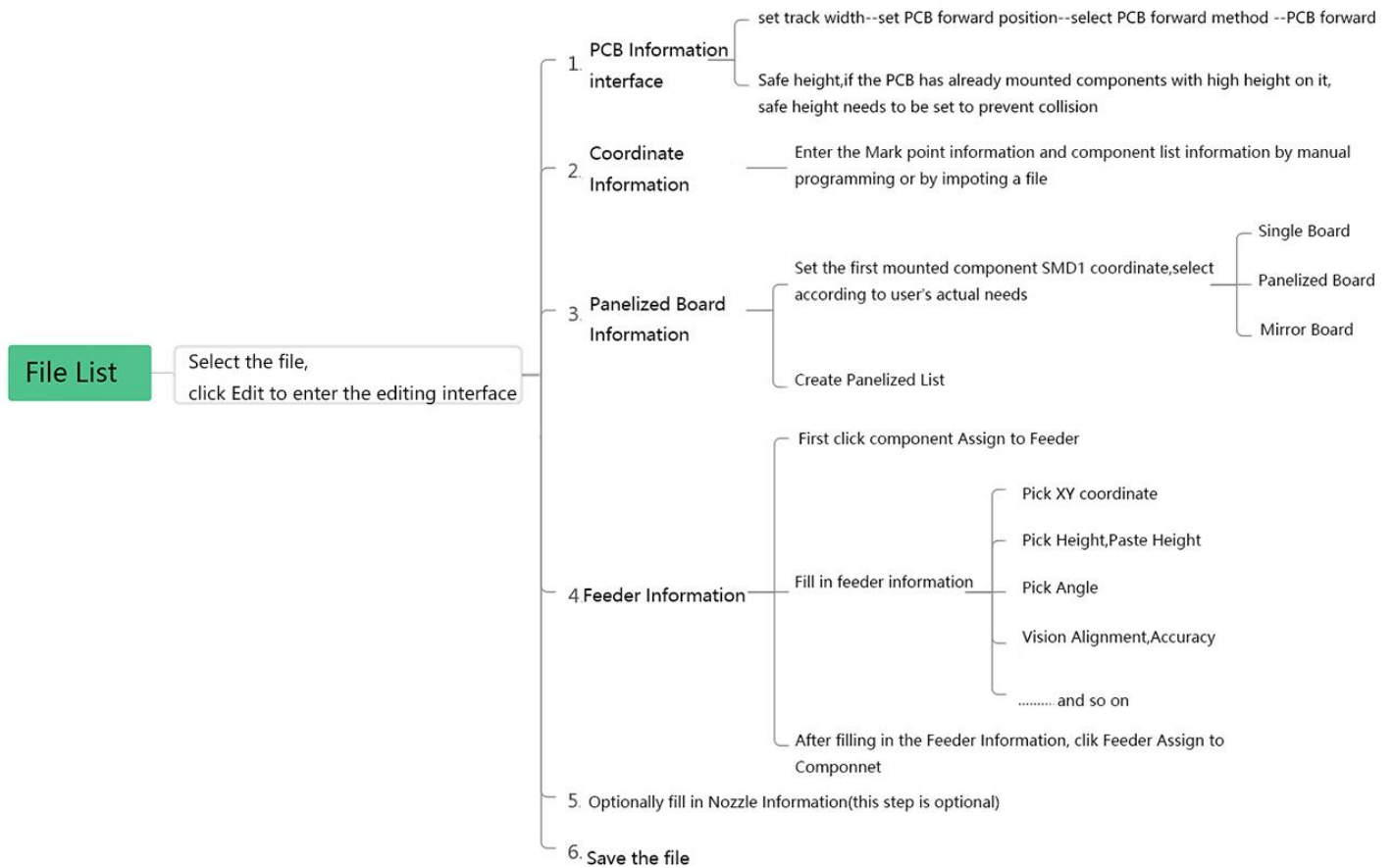
- | | |
|------------------------------------------|----------------------------|
| (1) Warning Light (Triple Color) | (7) USB port |
| (2) Safety cover | (8) Pause/start button |
| (3) Front Feeder Slots 1-33(Referential) | (9) Mouse keyboard bracket |
| (4) Electric Feeder Port | (10) Power Switch |
| (5) 12 inch high-definition display | (11) Air source input |
| (6) Emergency Button | (12) Heavy load pedestal |

2.4 Operation flow chart





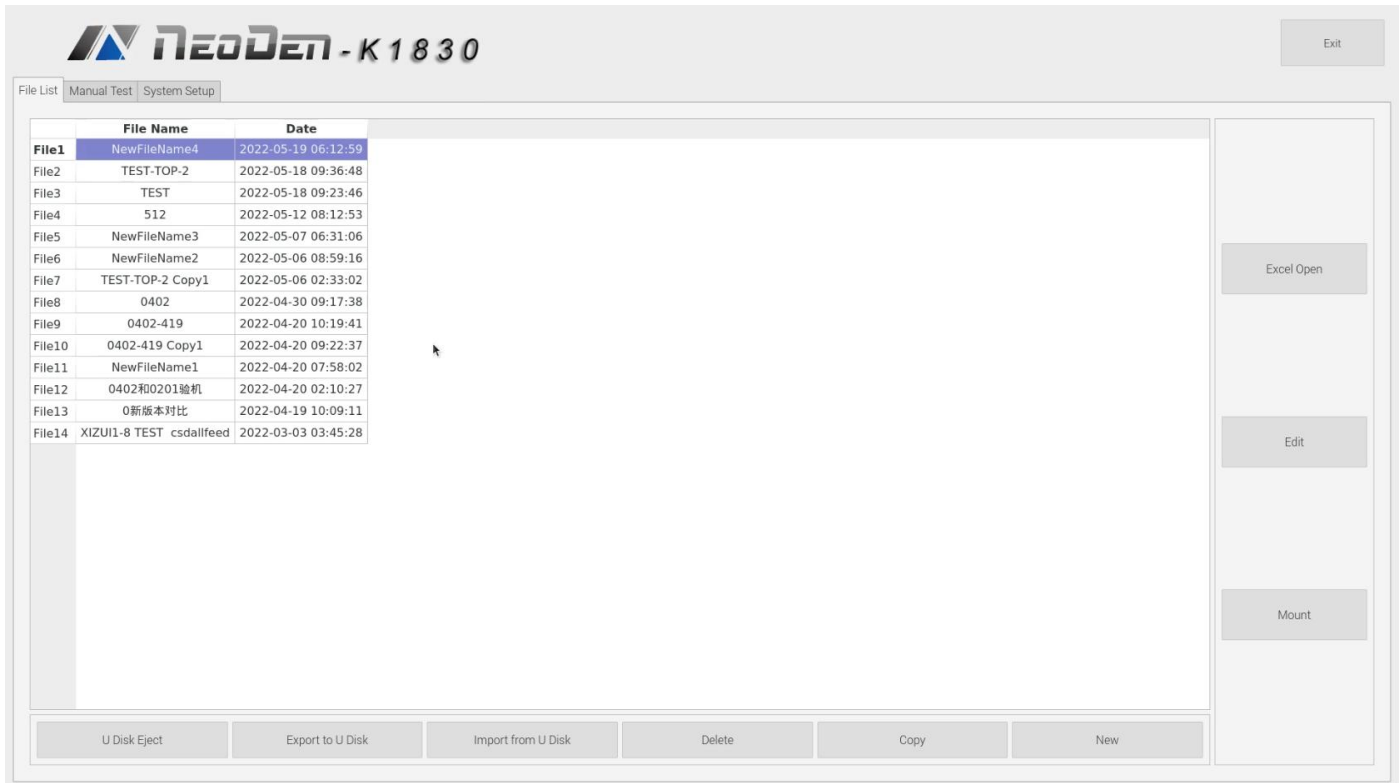
2.5 Flow chart of making a programming file



Note:

- The basic procedure of making a programming file by manual programming or import coordinate file is similar, but there are two different parts: component list and fiducial setting.
- Please find the detailed operation steps of the differences on relative pages.

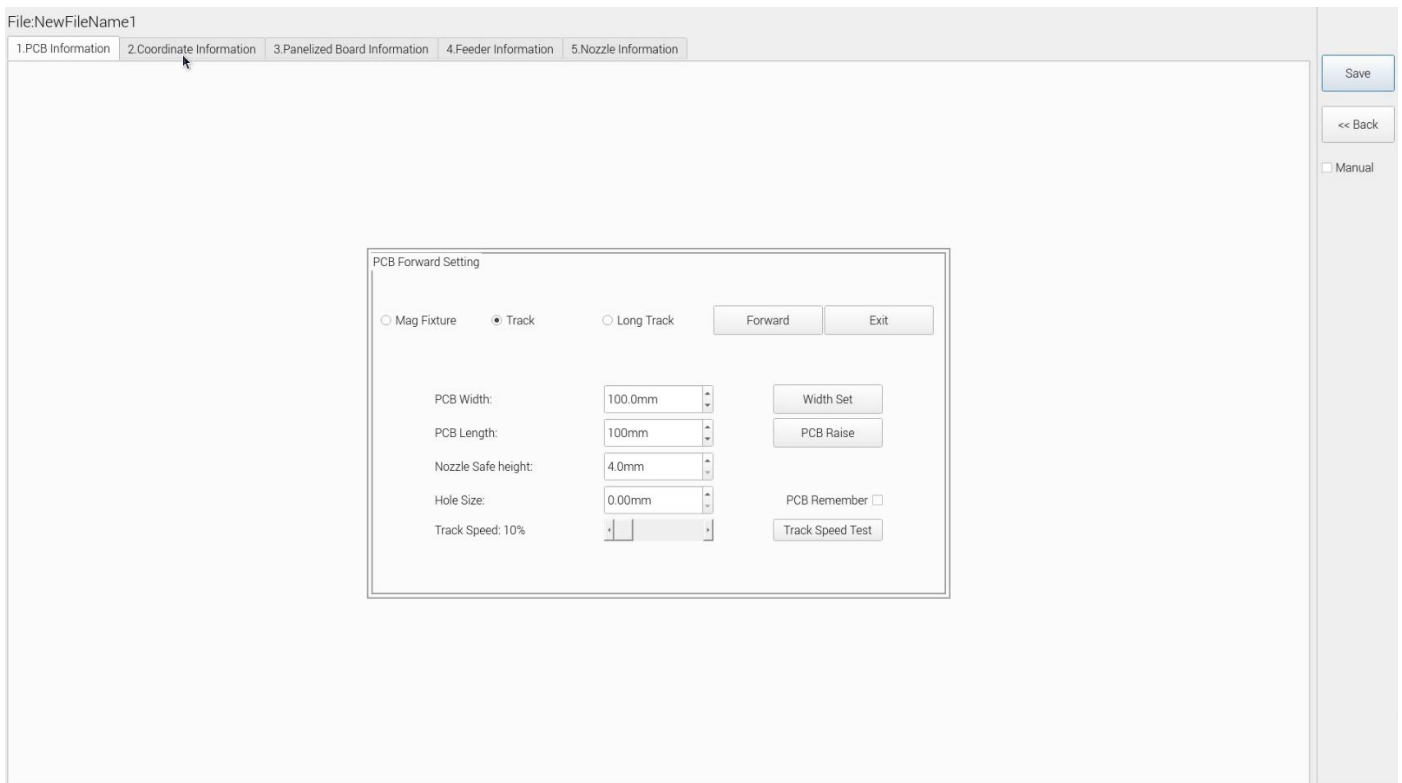
3. File List



1. Excel Open: the file can be modified directly in the Excel, simplifying the programming operation.
2. Edit: select a file and click Edit to enter the corresponding editing interface.
3. Mount: after editing the file, select the file and click processing to mount.
4. U Disk Eject: Eject the U disk safely.
5. Export to U Disk: connect a U disk, select the file and click Export, the file would be exported after the successful notice pops up. If there is an export file with the same name in the U disk, it will prompt whether to overwrite.
6. Import from U Disk: for the files that have been edited offline, they can be directly imported from U disk for mounting. After connecting U disk, click Import from U disk, select the corresponding files in the new window, and click OK, the file would be imported.
7. Delete: select the file that you do not need, and click delete.
8. Copy: select the corresponding file, click Copy, and the file list will generate a file of xxxcopy1. In order to prevent mis-operation, a new file can be copied before operation.
9. New: click Add to open the input window, input the file name, and click OK. At this time, when the file list interface displays new files, the operation is successful.

4. PCB Information

Choose one file that you need to edit in the File List, this is the first information you need to set up.

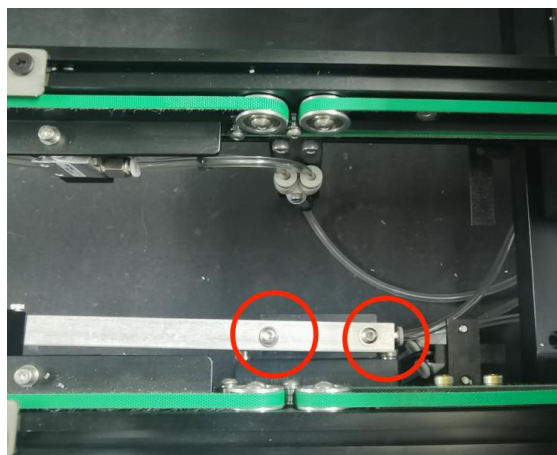


4.1 PCB Forward Setting

Firstly we need to set **PCB width**. Adjust the track width according to the actual PCB width(usually actual PCB width plus 1mm). Then click **Width Set**,follow the prompt window to check whether back to zero condition are met. After back to zero, the track width will be adjusted. After placing the PCB on the track,gently push the PCB back and forth by hand to confirm that the PCB has a small gap of about 1mm in the track, so that the PCB can pass smoothly.

Then set the **PCB Length** accordingly.

Secondly, determine the position of the stopper in the track (note: if you need to adjust the position of the stopper in the track, loosen the screw at the stopper, turn the stopper 180 degrees, and then tighten the screw) as shown in the figure below:



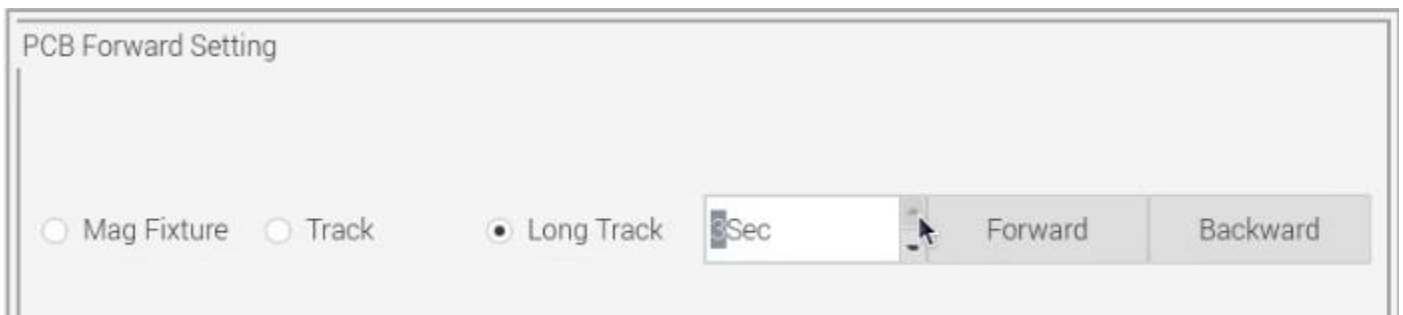
Forward: Click Forward, the PCB will stop at the Forward position by the head needle.

There are three modes in PCB Forward Setting: Mag Fixture, Track, Long Track. Select one of them that suits you.

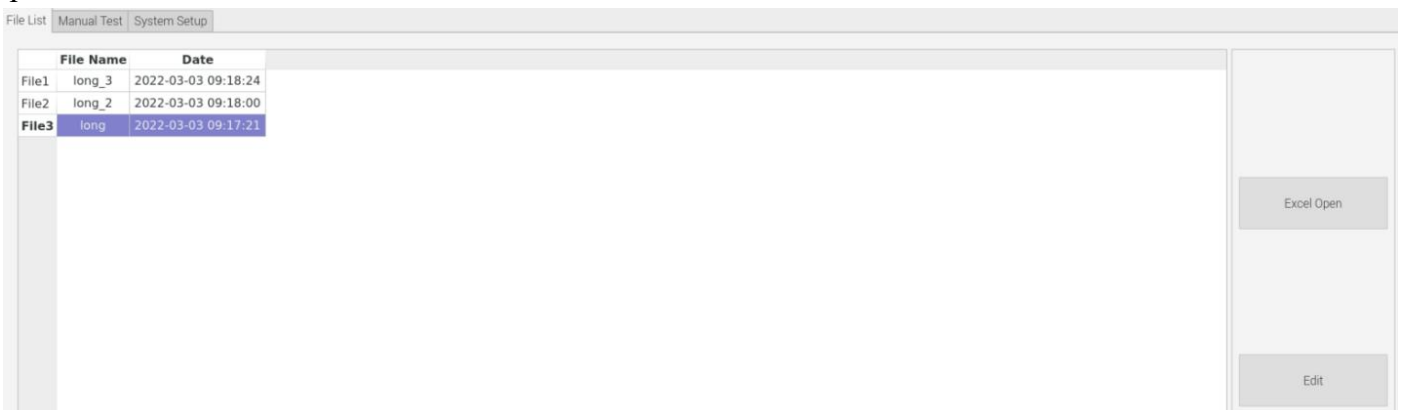
Mag Fixture: select Mag Fixture, place the PCB to be installed in the proper position in the mounting area, and then click "PCB Raise" to fix the PCB.

Track: select Track, put one PCB on the entrance, then click Forward, it will go inside the machine. Track mode is used in most case.

Long Track: select Long Track; if you are editing the first file, then choose 1sec, 2 sec for the second file, 3sec for the third file.



In the long track mode, three separate files need to be edited. The naming requirements are as follows: add an underscore after the second file name and the third file name (the underscore is English format) + the corresponding number of the file, there can not be any space in the file name, the file name is as follow picture shows:



Choose the first file (e.g. long), then click mount. All three files will be showed in the mounting interface.

Working step description of long track mode in mounting:

The long tracks sends feed signal to the front conveyor, and feed PCB to cylinder thimble 1 position, cylinder will raise the PCB, then thimble 1 will go down, PCB feeding phase 1 is completed. After above placement is completed, the PCB in the waiting area is released, feed to cylinder thimble 2 position, cylinder will raise the PCB, then thimble 2 will go down, PCB feeding phase 2 is completed. After above placement is completed, the PCB in the waiting area is released, feed to cylinder thimble 3 position, cylinder will raise

the PCB, then thimble 3 will go down, PCB feeding phase 3 is completed.

4.2 PCB Backward Setting

Backward means Eject. Click it, the PCB will be ejected to right side. No matter Mag fixture mode or Track mode, the head needle will go down in “track section 2”, track section 2 and 3 begin to work and PCB will feed to right side, and stops right above the sensor position. If there’s SMT conveyor connected and release signal to pnp machine, PCB will be automatically transit into SMT conveyor.

4.3 Safe Height

Please enter the height of the highest component to avoid any hit to the components which already placed on the PCB. During the placement process, the safety height will be involved in the calculation.

4.4 Track Speed

Different PCB boards have different requirements for the track speed. The track speed can be configured in the file, and the value can be seen by adjusting the slider. Click the **track speed test** to observe the speed of the track.

4.5 Hole Length

If it is a hollowed PCB, please input the length of the hole; and check the option ‘PCB remember’. If the hollowed hold of the board passes through the end sensor of the track 3 during processing, it will has the memory function.

5. Coordinate Information

5.1 PCB Fiducial Setting

Working together with SMD1 position settings, fiducial settings are important to let the machine do the math calculation of the component coordinates. The specific position and direction of PCB could be confirmed via fiducial information. Only in this way the next step of mounting work can carry out. PCB fiducial setting interface see below fig.



	Pos X	Pos Y	Min	Max	Flash	Brightness	Range	Circle Degree	Mode	Camera
Fiducial 1	4	9	0.8	1.2	Inner	20	4	80	White Point	Left Camera
Fiducial 2	136	91	0.8	1.2	Inner	20	4	80	White Point	Left Camera

Panelized fiducials(local fiducials): Fiducials on each panelized board. Machine will scan fiducials on each panel when doing mountings.

Single fiducials(global fiducials): It is mainly used for a single PCB board and multiple identical PCB boards(each panel) consistent of the whole board (Notice: coordinate programming is done as a single board)

Generally, we need to select 2 or 3 fiducials.

Suggestion for the fiducial settings: The selection of the mark point of the panelized board and the mark of the single board is relatively flexible.

If it's a big board contains several small PCBs (note: the csv.file only contains the component coordinates on one PCB), and there are fiducial points on each small PCB; we then suggest to set the panelized fiducials (local fiducials), it will carry out more precise placement effect.

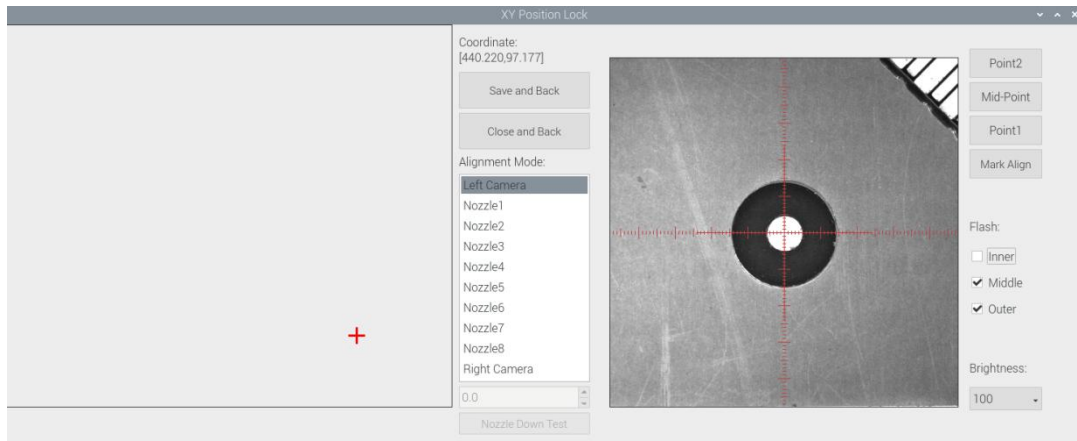
If it is a big single board(only one PCB), or many same small PCBs formed a whole board (note: the csv. file contains all the components coordinate on the big PCB), we then suggest to set the Single fiducials(global fiducials).

Manual alignment: If the fiducial point quality is poor and the recognition is not accurate, the reference position can be determined manually. If there is no fiducial point on the PCB, which can through some location holes and set up some special reference point manually to replace and confirm reference position. Note: Generally use SMD1 coordinate in chip list and the one that is relatively easy to find far away from SMD1 as fiducial points. In this way, the relative placement effect will be better during placement, the reference point is determined manually. Need to manually align the fiducials during the mountings.

Auto alignment: The machine will scan and align fiducial points automatically during the mountings.

Fiducials Coordinate: If doing file import programming, meaning unticking Manual button and importing the coordinate file directly rather than align each component, pls just copy the fiducial coordinates from the pcb designer directly.

If doing manual programming, meaning ticking Manual button and you need to align each component manually, pls select mark Align on the list and click "align", enter the image capture page, and then find the center of the fiducial via movement, click "mark align" see below figure, and then click "Save and Back".



Finding fiducial center manually

PCB Fiducial Setting

Panelized Fiducial Setting Single Fiducial

Fiducial Alignment

Manual Alignment Auto Alignment

New Delete Save

	Pos X	Pos Y	Min	Max	Flash	Brightness	Range	Circle Degree	Mode	Camera
Fiducial 1	4	9	0.8	1.2	Inner	20	4	80	White Point	Left Camera
Fiducial 2	196	91	0.8	1.2	Inner	20	4	80	White Point	Left Camera

<< Back Manual

Min, max value: It means the size of fiducials, adjust the value according to the fiducial type.

Flash: It has different combinations: inner,middle, outer,inner and middle,middle and outer and all. The user can make adjustments according to fiducial type.

Brightness: The user can adjust the brightness when align the fiducial point according to actual situation.

Range: If there are interference points near the fiducials, you can input a certain value and ensure identify the fiducials more accurately.

Circle Degree: Refers to the roundness of the fiducials. If the fiducial is not so round, pls devalue the value of it to let the camera recognize it better.

Mode: white point and black point, select black point mode if have hole and bright point,select white point mode if have bright point.

Camera: Support select left camera and right camera(user can select the camera for calibration according to the actual situation),also can select default setting camera. If user select camera that can't reach the position, the machine will use corresponding camera during work.

New and Delete: Click "new" to add a new fiducial (base on mode of the latest fiducial). Click "delete" to remove the selected fiducials.

5.2 Component List Setting

Display the information and mounting order of components. The components' quantity and mounting information can be added through manual programming or importing files, see below figure:

File:NewFileName1

1.PCB Information 2.Coordinate Information 3.Panelized Board Information 4.Feeder Information 5.Nozzle Information

PCB Fiducial Setting

Panelized Fiducial Single Fiducial

Fiducial Alignment

Manual Alignment Auto Alignment

New Delete

	Pos X	Pos Y	Min	Max	Flash	Brightness	Range	Circle Degree	Mode	Camera
Mark1	325	325	0.8	1.2	Inner	20	4	80	White Point	Left Camera
Mark2	325	325	0.8	1.2	Inner	20	4	80	White Point	Left Camera

Manual

	Feeder	Comment	Footprint	Designator	Nozzle	Pos X	Pos Y	Angle	Place
Comp1	1	10k	0402	R1	1	325	325	0	<input checked="" type="checkbox"/>
Comp2	1	10k	0402	R1	1	326	325	0	<input checked="" type="checkbox"/>
Comp3	1	10k	0402	R1	1	326	325	0	<input checked="" type="checkbox"/>

Import Top Layer

Import Bottom Layer

Auto Programming

New

Delete

Move Up

Move Down

Move to First

Search Designator

To Current Position

Position Correction

Component Division

Batch Create

5.2.1 Manual programming

If doing manual programming, all the components coordinates and fiducial coordinates are aligned via machine camera. Please check the follow steps of how to do the manual programming.

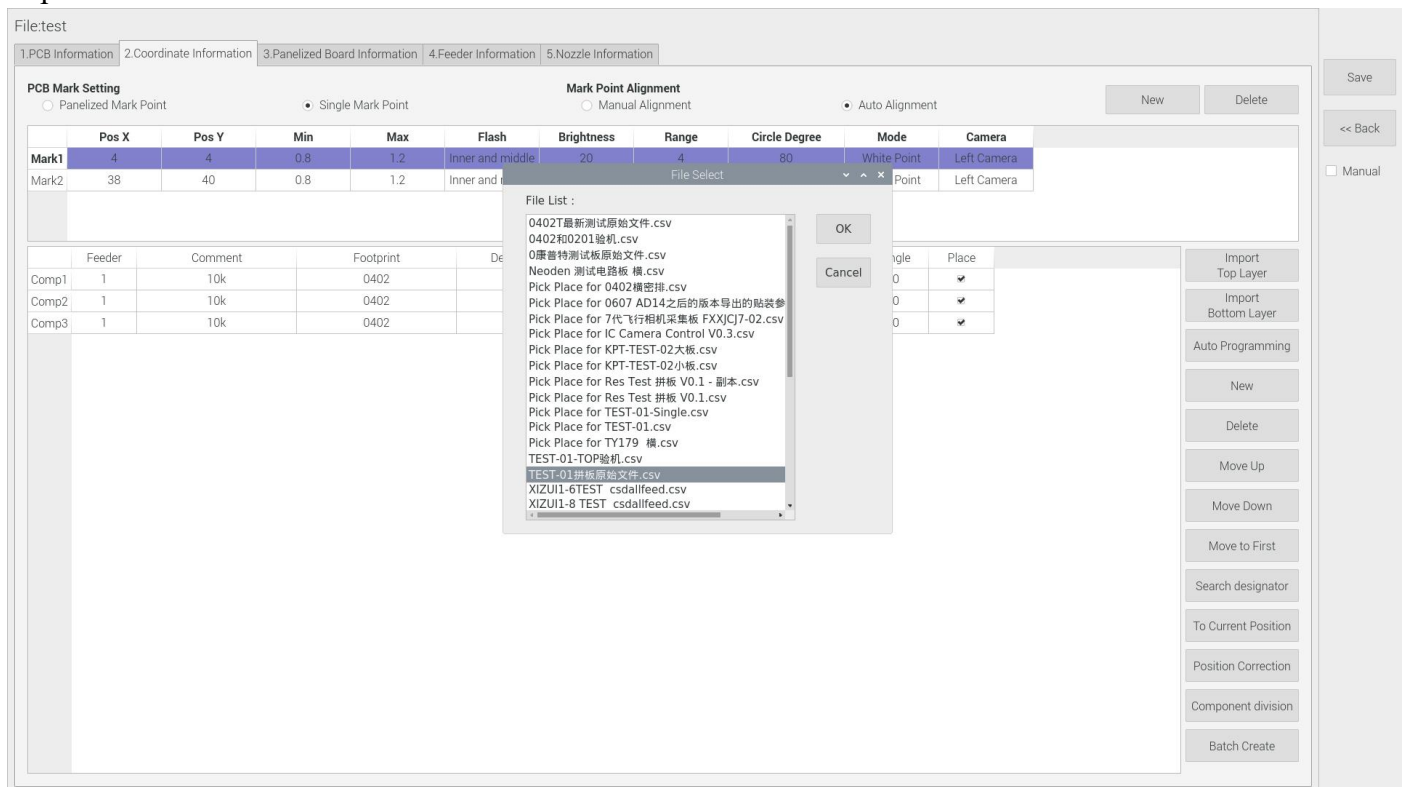
1. Need to tick Manual button on the top right firstly(coordinates are generated from the machine directly);
2. Fiducial settings: Click Align to enter the lock interface. According to the image presented by the Mark camera, find the fiducial point, and click Fiducial Align to auto align the center of it. After the coordinates of the fiducials finished, please continue to setup the Brightness and flash modes, and so on.
3. SMD1 seting: Click Align to enter the lock interface. According to the image presented by the Mark camera,need to find the pad on the PCB and confirm the center position coordinates; then click save.
4. Complete information of each component: Feeder refers to which feeder No. the component located; Nozzle refers to which nozzle used to mounting the component; Comment refers to the component's value; Footprint refers to the common footprint name as 0402,0603,0805 etc; XY coordinate refers to the position of where the component is mounted; Skip setting includes true or false, false means keep mounting, true means skip mounting this component. After finish all parameters' editing, the setting of first component information finish.
5. Click 'New' to add one row on the component list. The information will exactly copy from the last row. Click align to find the component's right coordinate. Then click save then edit other information such as value, footprint and angle etc. Keep adding new component until the whole PCB finish.

6. Please note that the feeder and nozzle do not need to be edited manually. It can be set through feeder setting interface with ‘Feeder Assign to Component’ button to assign the information to component list automatically.

5.2.2 File Import Programming

Different from manual programming, all the components coordinates when doing file import programming could be imported to the machine by just clicking the button ‘import top layer’ or ‘import bottom layer’; and the fiducial coordinates are copied from the EDA software. Please check the follow steps of how to do the file import programming.

1. Untick Manual button on the top right.
2. Need to have the coordinate file firstly which exported from the pcb designer, such as Altium Designer.
3. Insert the coordinate file via one USB into the machine, import the coordinate file by clicking related layer file import button. The right side click ‘import top layer’ and the reverse side click ‘import bottom layer’. It will pop up a selecting window, choose the coordinate file and click save, the information will be imported to the list.



5.2.3 Other Functional Buttons

There are also other functional buttons on the right side, please check how they work.

1. New

To add a new component, the component list will copy one row from the adjacent row, then modify the component information.

2. Delete component

Select the wrong component row, click delete to remove the component.

3. Movement of the components

Move up: To move the selected component upward

Move down: To move the selected component downward

Move to first: To move the selected component to the first row. Please notice the first row component must be the same as the first component to place on the PCB.

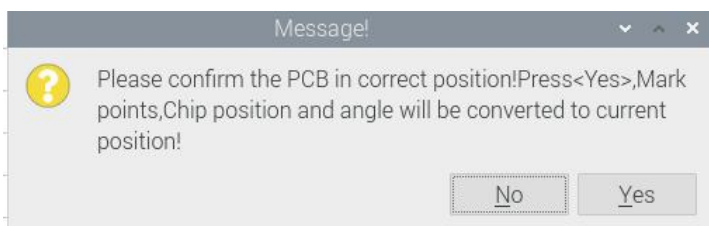
4. Search designator

It's convenient for users to find the specific components, click the seek footprint, and input footprint name in new window, click "OK" and finish.

5. To current position

After finish all editing operation, click Save firstly. Then click To current position. It will pop up the above dialogue, click yes, the machine will recognize the fiducials automatically and convert all file imported coordinates to machine coordinates. After convert successfully, it will pop up a dialogue, click

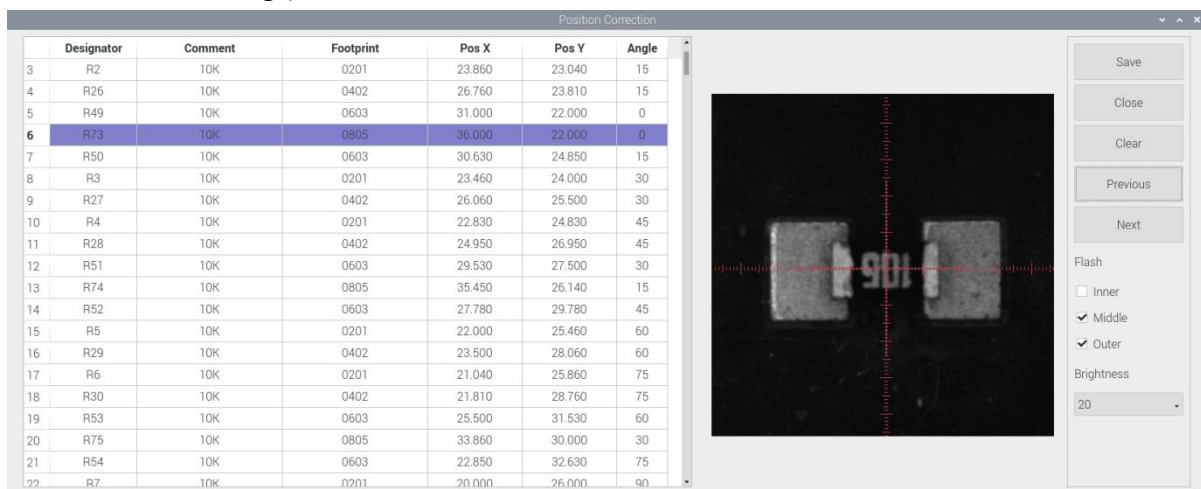
Align to check if the components are centered or not. Then pls do not click Save, just Back, and the coordinates will remain as the filed imported coordinates.



6. Position correction

After the first mounting trial, if there is any deviation (deviations are regular and relatively consistent), please click Position Correction to enter the new vision page. Click the **left mouse** button to align the center of the placed component; Click the **right mouse** button to align the center of pad. Then correct next one until finish all components and save. The machine will remember the positions after correction. It will fix it automatically at the second placement trial.

(kindly note, it's used after the components used, we do not suggest to use it as checking the coordinates before mountings)

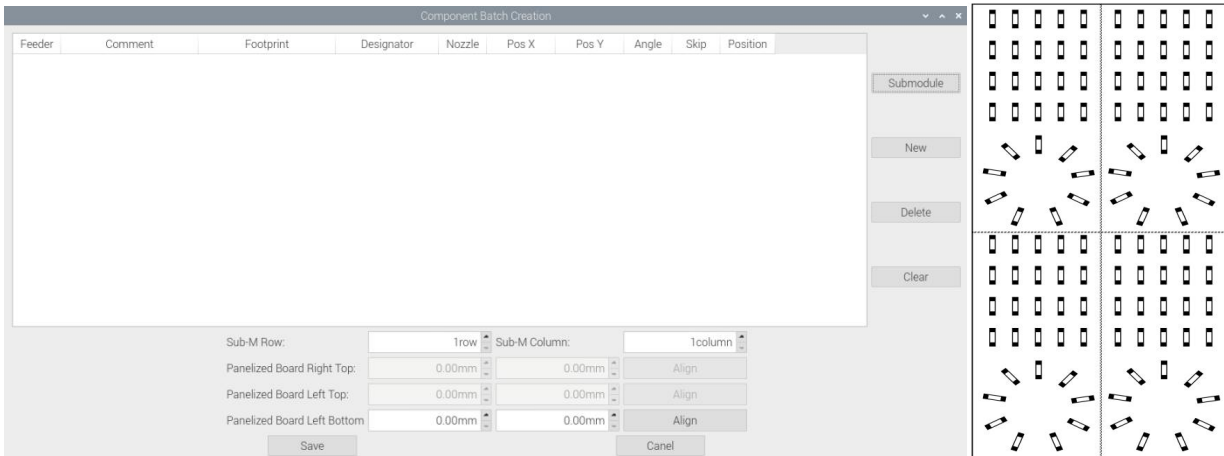


7. Component division

Divide one kind of component multiply, input footprint, comment, qty etc. according to the prompt dialog box. After division, the divided ones will be marked with [xx] in comment column (such as the comment of 104, it will show as 104[1], 104[2], 104[3])

8. Batch Create

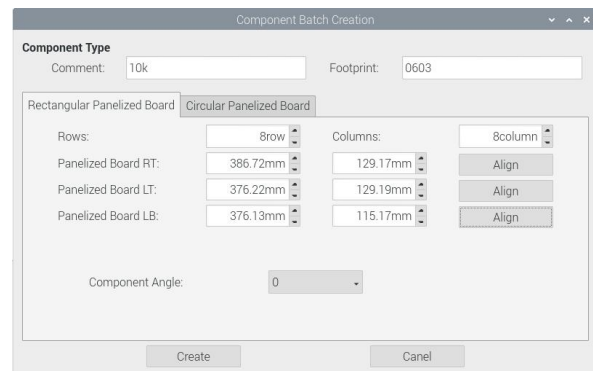
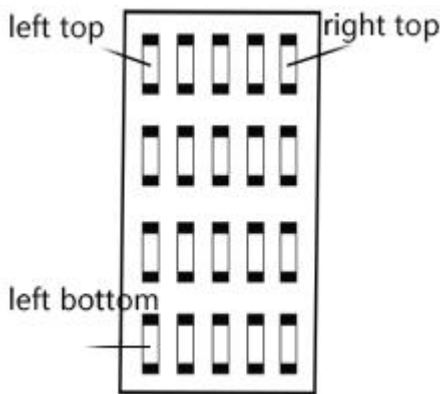
Some circuit boards are relatively regular and easy in real editing situation. For instance the long LED boards. For this type of circuit board, we can use Batch Create to generate the components very conveniently, the interface as shown in figure:



For example: we can see the above picture which has a rectangular block and a circular block to form a small panel. We call such panel as submodule. We can generate the whole panel board through creating a submodule. Two ways to generate submodules: rectangle and circle.

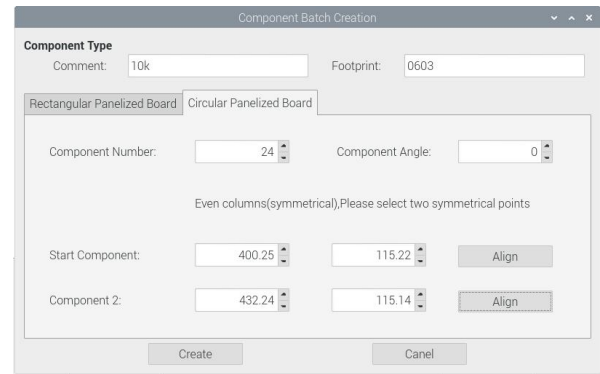
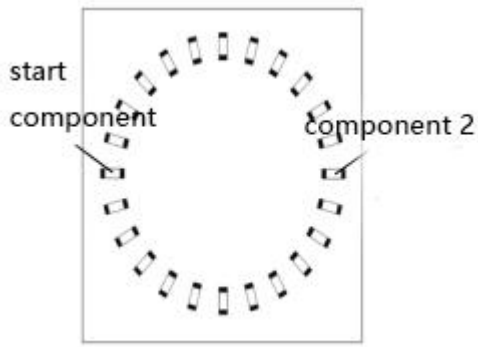
A. The way to generate rectangle panel: Click: “submodule”, below dialogue will pop up. Please fill in specification and footprint of component. We can see the panel has four rows and five columns. Fill in 4 rows and 5 columns in the dialogue, and align the three components(right top, left top, left bottom). The component degree will be based on actual situation.

Click “create”, the machine will generate all the coordinate automatically.

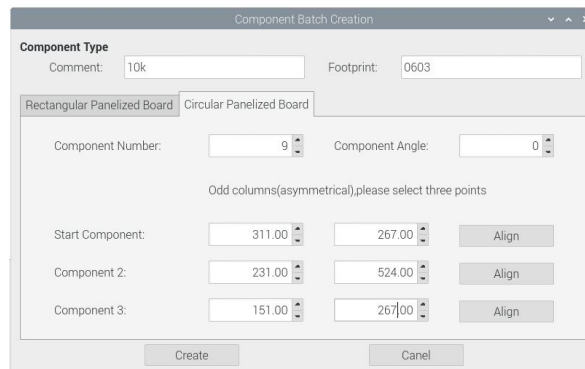
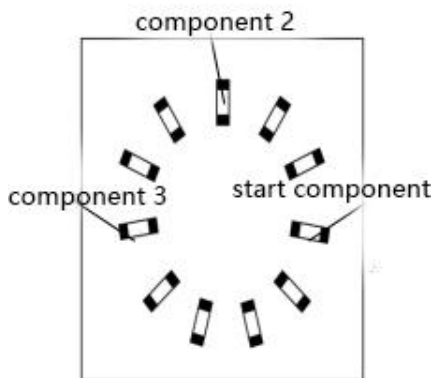


B. The way to generate circle panel:

When the quantity of component is even: Click: “batch create”, below dialogue will pop up. Please fill in specification and footprint of component. Choose circle panel, the component number is 24 in the example, the angle is 0. Since the quantity of component is even number, we only need to find two symmetry components to align, Start point and Component point 2. After that, click create, the 24 components coordinate will be generate Automatically



When the quantity of component is odd, the component type will be the same. We can see that the panel has 9 components, as the quantity number is odd, we need to find 3 components that are in isosceles triangle, and then align the coordinates of those three points in turn. Click 'create' to generate 9 components' coordinate in circle panel.



All components setting on this files list, like: nozzle selecting, stack setting, the location of pick components, adjustment setting, and others components' setting need to be finished here.

	Feeder	Comment	Footprint	Designator	Nozzle	Pos X	Pos Y	Angle	Skip	Position
Comp1	11	10k	0603	R1	1	376.220	129.190	0	<input type="checkbox"/>	Align
Comp2	12	10k	0603	R1	2	377.720	129.187	0	<input type="checkbox"/>	Align
Comp3	13	10k	0603	R1	3	379.220	129.184	0	<input type="checkbox"/>	Align
Comp4	14	10k	0603	R1	4	380.720	129.181	0	<input type="checkbox"/>	Align
Comp5	15	10k	0603	R1	5	382.220	129.179	0	<input type="checkbox"/>	Align
Comp6	16	10k	0603	R1	6	383.720	129.176	0	<input type="checkbox"/>	Align
Comp7	17	10k	0603	R1	7	385.220	129.173	0	<input type="checkbox"/>	Align
Comp8	18	10k	0603	R1	8	386.720	129.170	0	<input type="checkbox"/>	Align
Comp9	11	10k	0603	R1	1	376.207	127.187	0	<input type="checkbox"/>	Align
Comp10	12	10k	0603	R1	2	377.707	127.184	0	<input type="checkbox"/>	Align
Comp11	13	10k	0603	R1	3	379.207	127.181	0	<input type="checkbox"/>	Align
Comp12	14	10k	0603	R1	4	380.707	127.179	0	<input type="checkbox"/>	Align
Comp13	15	10k	0603	R1	5	382.207	127.176	0	<input type="checkbox"/>	Align

Click save, it will generate related component list as below:

File:test

1.PCB Information 2.Coordinate Information 3.Panelized Board Information 4.Feeder Information 5.Nozzle Information

PCB Mark Setting Panelized Mark Point Single Mark Point **Mark Point Alignment** Manual Alignment Auto Alignment New Delete

	Pos X	Pos Y	Min	Max	Flash	Brightness	Range	Circle Degree	Mode	Camera
Mark1	196	91	0.8	1.2	Middle	80	4	80	White Point	Left Camera
Mark2	4	9	0.8	1.2	Middle	80	4	80	White Point	Left Camera

Feeder	Comment	Footprint	Designator	Nozzle	Pos X	Pos Y	Angle	Place
Comp1	mark	MARK	mark4	1	96.000	46.000	90.00	▼
Comp2	10K	0402	R136	1	62.000	33.500	0.00	▼
Comp3	10K	0402	R135	1	60.000	33.500	0.00	▼
Comp4	10K	0402	R134	1	58.000	33.500	0.00	▼
Comp5	10K	0402	R133	1	56.000	33.500	0.00	▼
Comp6	10K	0402	R132	1	54.000	33.500	0.00	▼
Comp7	10K	0402	R131	1	52.000	33.500	0.00	▼
Comp8	10K	0402	R130	1	50.000	33.500	0.00	▼
Comp9	10K	0402	R129	1	48.000	33.500	0.00	▼
Comp10	10K	0402	R128	1	62.000	35.000	0.00	▼
Comp11	10K	0402	R127	1	60.000	35.000	0.00	▼
Comp12	10K	0402	R126	1	58.000	35.000	0.00	▼
Comp13	10K	0402	R125	1	56.000	35.000	0.00	▼
Comp14	10K	0402	R124	1	54.000	35.000	0.00	▼
Comp15	10K	0402	R123	1	52.000	35.000	0.00	▼
Comp16	10K	0402	R122	1	50.000	35.000	0.00	▼
Comp17	10K	0402	R121	1	48.000	35.000	0.00	▼
Comp18	10K	0402	R120	1	62.000	36.500	0.00	▼
Comp19	10K	0402	R119	1	60.000	36.500	0.00	▼
Comp20	10K	0402	R118	1	58.000	36.500	0.00	▼
Comp21	10K	0402	R117	1	56.000	36.500	0.00	▼
Comp22	10K	0402	R116	1	54.000	36.500	0.00	▼
Comp23	10K	0402	R116	1	54.000	36.500	0.00	▼

Save
 << Back
 Manual

Import Top Layer
 Import Bottom Layer
 Auto Programming
 New
 Delete
 Move Up
 Move Down
 Move to First
 Search designator
 To Current Position
 Position Correction
 Component division
 Batch Create

5.3 Auto Programming

After import the coordinate file into component list (or manually programmed the coordinate file), click “Auto programming”, it will turn to the related interface:

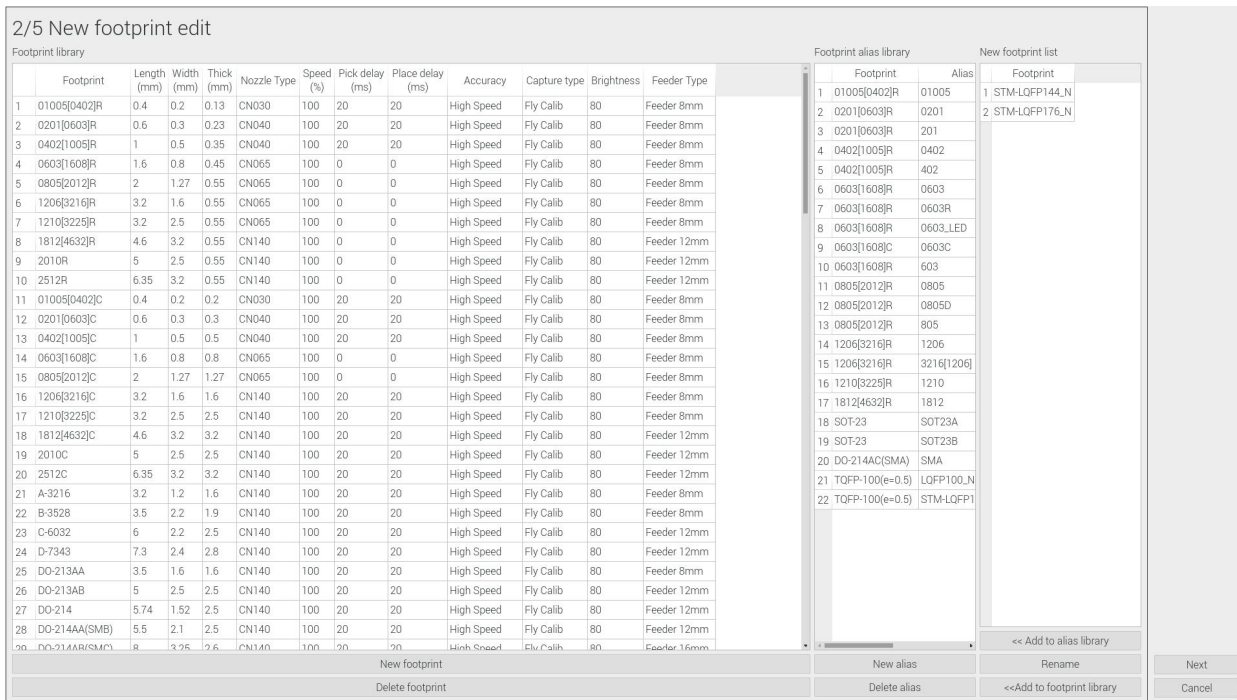
The first interface is “1/5 place order edit”, it is component list information, you can directly click “Next”.

1/5 Place order edit

Comment	Footprint	Designator	Pos X	Pos Y	Angle	
1	TQFP100	STM-LQFP100_N	U1	83	22	0
2	10K	0201	R1	24	22	0
3	10K	0201	R2	23.86	23.04	15
4	10K	0201	R3	23.46	24	30
5	10K	0201	R4	22.83	24.83	45
6	10K	0201	R5	22	25.46	60
7	10K	0201	R6	21.04	25.86	75
8	10K	0201	R7	20	26	90
9	10K	0201	R8	18.96	25.86	-75
10	10K	0201	R9	18	25.46	-60
11	10K	0201	R10	17.17	24.83	-45
12	10K	0201	R11	16.54	24	-30
13	10K	0201	R12	16.14	23.04	-15
14	10K	0201	R13	16	22	0
15	10K	0201	R14	16.14	20.96	15
16	10K	0201	R15	16.54	20	30
17	10K	0201	R16	17.17	19.17	45
18	10K	0201	R17	18	18.54	60
19	10K	0201	R18	18.96	18.14	75
20	10K	0201	R19	20	18	-90
21	10K	0201	R20	21.04	18.14	-75
22	10K	0201	R21	22	18.54	-60
23	10K	0201	R22	22.83	19.17	-45
24	10K	0201	R23	23.46	20	-30
25	10K	0201	R24	23.86	20.96	-15
26	10K	0402	R25	27	22	0
27	10K	0402	R26	26.76	23.81	15
28	10K	0402	R27	26.06	25.5	30
29	10K	0402	R28	24.95	26.95	45
30	10K	0402	R29	23.5	28.06	60
31	10K	0402	R30	21.81	28.76	75
32	10K	0402	R31	20	29	90
33	10K	0402	R32	18.26	29.26	75

Next
Cancel

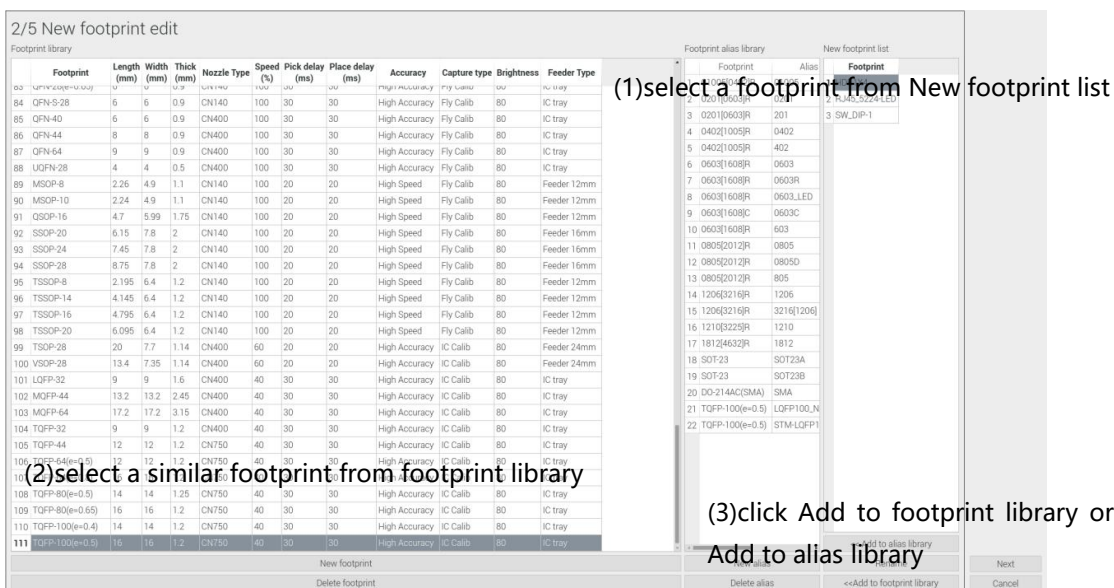
The second interface is “2/5 New footprint edit”. Left part is the footprint library (includes component L/ W/ T, nozzle type, feeder type etc.); Middle part is footprint alias library (for the same footprint, different engineers have their own naming conventions, so we call it “footprint alias library”); Right part is new footprint list (if there’s new footprint which not in the left footprint library, it will be showed in this area)



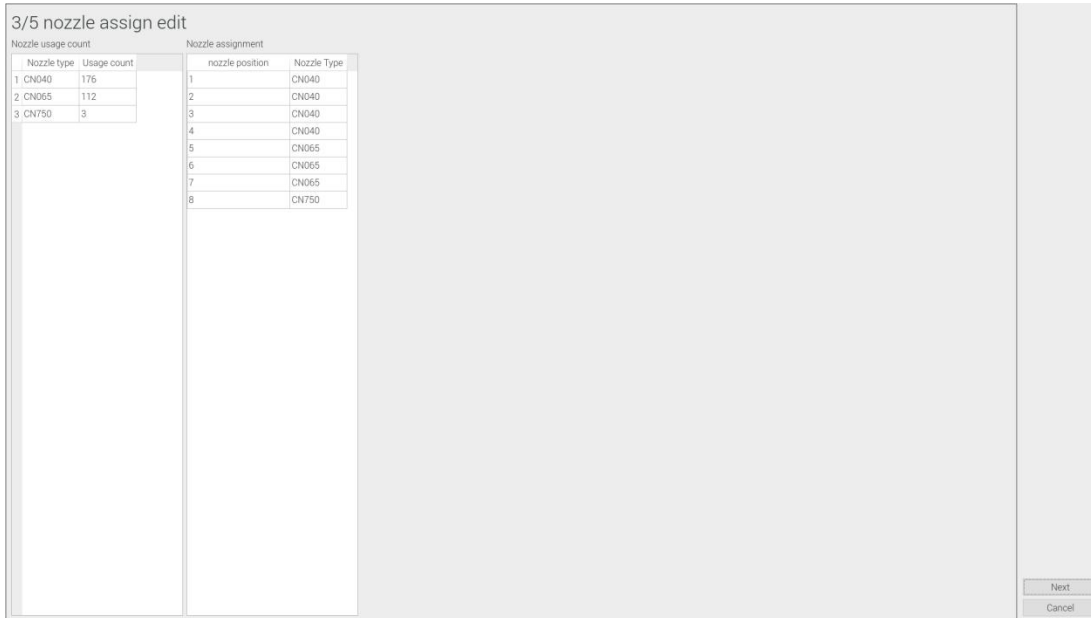
How to add these new footprint information to the footprint library? Three options for your selection:

1. Click “New footprint”, it will show a demo footprint line in the “Footprint library”, please manually type into the new footprint (showed on the right part in “New footprint list” area) information into it, then click any blank place, you’ll find the related information will disappear in the right part “New footprint”, that means it has been successfully added into Footprint library now.
2. Select a new footprint from the right part “New footprint list”, click “Add to footprint library”, then manually fulfill its related information will be ok.
3. If there’s similar footprint in left side, please select one new footprint (from the right side “New footprint list”) and then select a similar footprint in the left side “Footprint library”, then click “Add to footprint library”, you’ll find a new similar demo footprint showed, just modify its information will be ok.

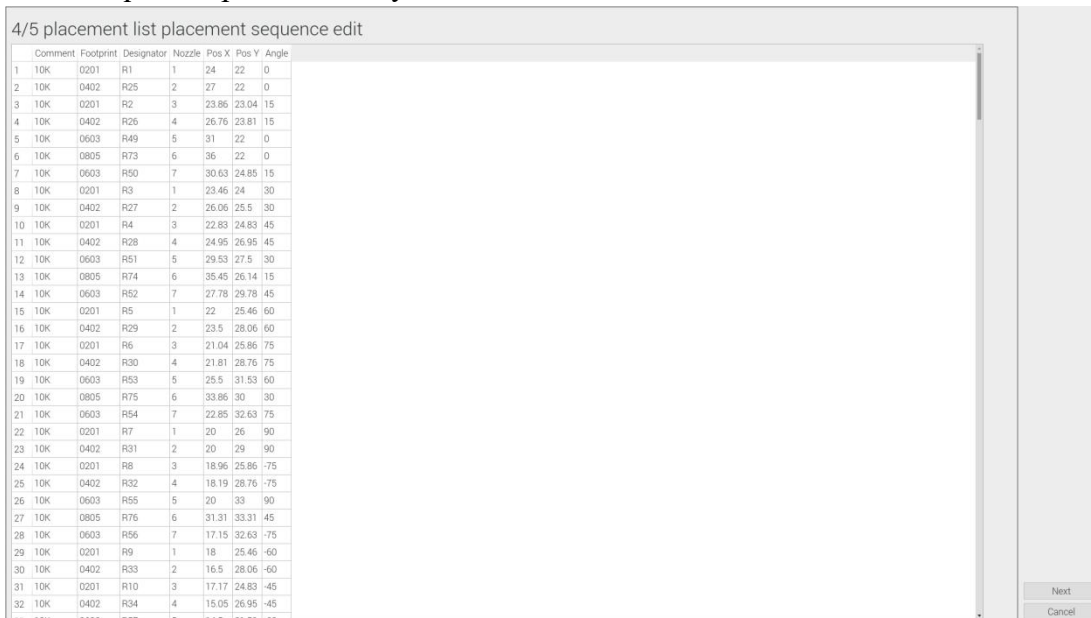
If the new footprint belongs to the type of footprint alias, please select the new footprint (from the right side “New footprint list”) and then select a similar footprint in the left side “Footprint library”, then click “Add to alias library”. Before click “Next”, please must make sure all the new footprints in the “New footprint list” are added into the library (or alias library).



After click “Next”, it will turn to the **third interface “3/5 nozzle assign edit”**. Left part will show which type of nozzle be used, also will count the times it was used. Right part will be the assignment against nozzle count times. If you wanna adjust it, please directly double-click the nozzle type and fill into the one you need. If any nozzle head is not available to use, please directly set the related nozzle type as blank, then click “Next”.



The fourth page is “**placement list placement sequence edit**”, it is showed the optimized placement sequence, please directly click “Next”



The final page is “**feeder stack edit**”, it will show components were assigned to which stack position and what kinds of nozzle be used etc., please directly click “OK“ to finish the automatic programming.

5/5 feeder stack edit

Stack	Component	Nozzle Type	Usage count
1			
2			
3			
4			
5			
6			
7	0201/10K	CN040	88
8	0402/10K	CN040	88
9			
10	0805/10K	CN065	24
11	0603/10K	CN065	88
12			
13			
14			
15			
16			
17			
18			
19			
20			
21			
22			
23			
24			
25			
26			
27			
28			
29			
30			
31			
32			
33			

OK
Cancel

After that, you'll find the information (placement sequence, nozzle assignment) in component list changed.

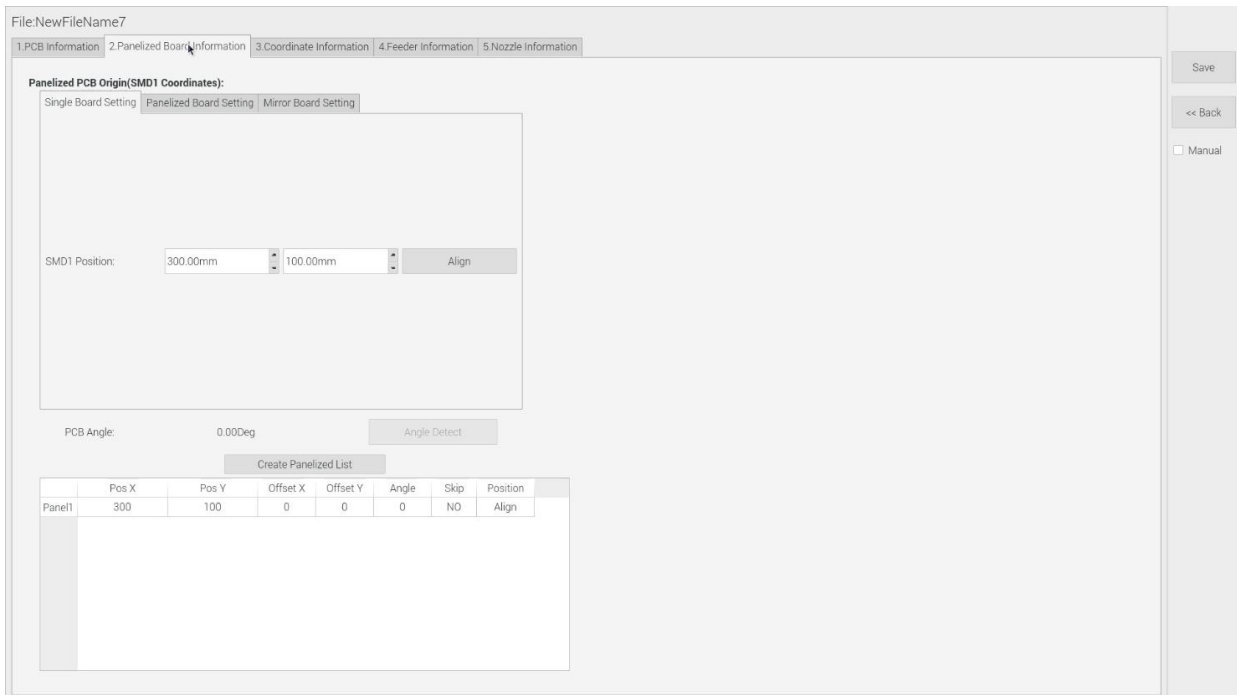
6. Panelized Board Information

This is mainly to determine the first component on single or panelized PCB of manual program or imported file program. The principle is to collect and calculate the data of each board's relative spacing, in order to achieve the calculation of the real coordinate.

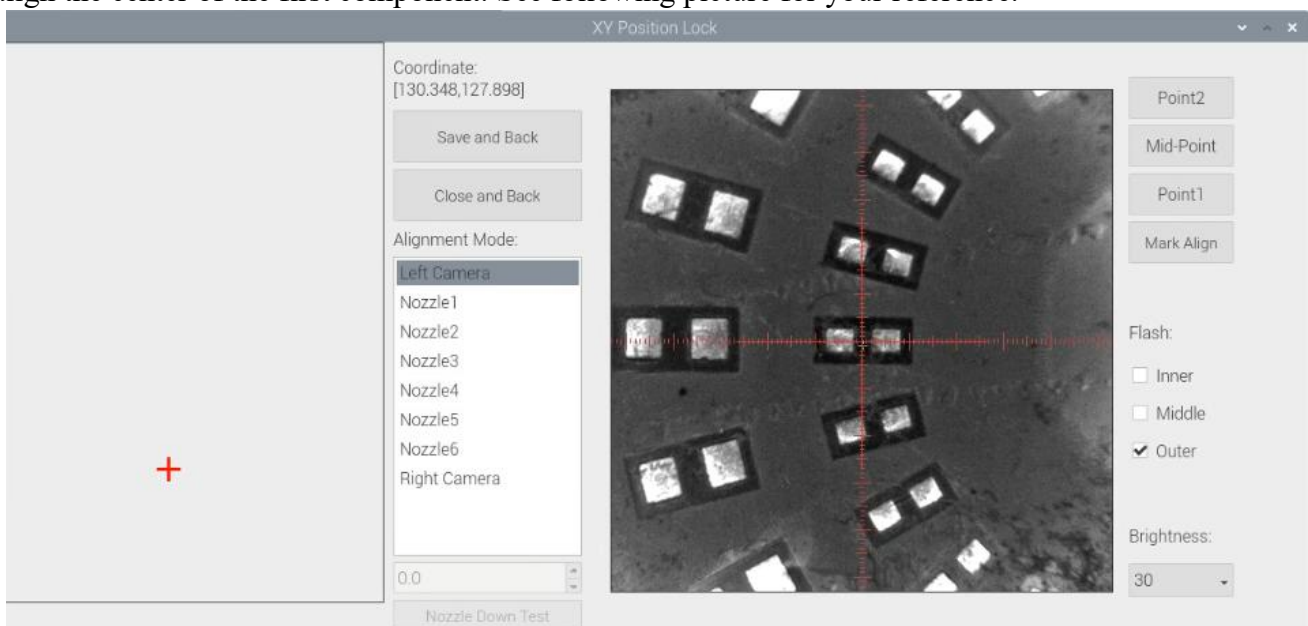
6.1 SMD 1 Position Setting

There are three modes of the SMD1 position setting according to the PCB types.

1. Single Board Setting



Click Single Board Setting, then press 'align' button of the SMD1 position in the PCB. We're choosing the first component on the PCB. We'll enter the vision align interface to find the first component, and need to align the center of the first component. See following picture for your reference.



After finding the center of the first component, then click “Save and Back”, it will go back to the previous interface.

Notice: when you program under ‘Manual’ mode, as we cannot assume the related PCB to be absolute 90° or 0°, we need to setting the “PCB angle” (angle deviation of PCB board compares to rails). To minimize the deviation, please select two points in parallel positions, machine can calculate the PCB angle automatically.

When you program under the mode of import coordinate file, no need to set this step. The default angle under this mode will be 0°.

2. Panelized Board Setting

File:test Copy1

1.PCB Information 2.Coordinate Information 3.Panelized Board Information 4.Feeder Information 5.Nozzle Information

Panelized PCB Origin(SMD1 Coordinates):

Single Board Setting Panelized Board Setting Mirror Board Setting

Rows: 2 Columns: 6

Right Top: 589.98mm 139.69mm Align

Left Top: 402.15mm 140.01mm Align

Left Bottom: 402.14mm 106.76mm Align

PCB Angle: Angle Detect

Create Panelized List

	Pos X	Pos Y	Offset X	Offset Y	Angle	Skip	Position
Panel1	402.140	106.760	0	0	0	NO	Align
Panel2	439.706	106.696	0	0	0	NO	Align
Panel3	477.272	106.632	0	0	0	NO	Align
Panel4	514.838	106.568	0	0	0	NO	Align
Panel5	552.404	106.504	0	0	0	NO	Align
Panel6	589.970	106.440	0	0	0	NO	Align
Panel7	402.150	140.010	0	0	0	NO	Align
Panel8	439.716	139.946	0	0	0	NO	Align
Panel9	477.282	139.882	0	0	0	NO	Align

Save

<< Back

Manual

panelized reference Panelized board

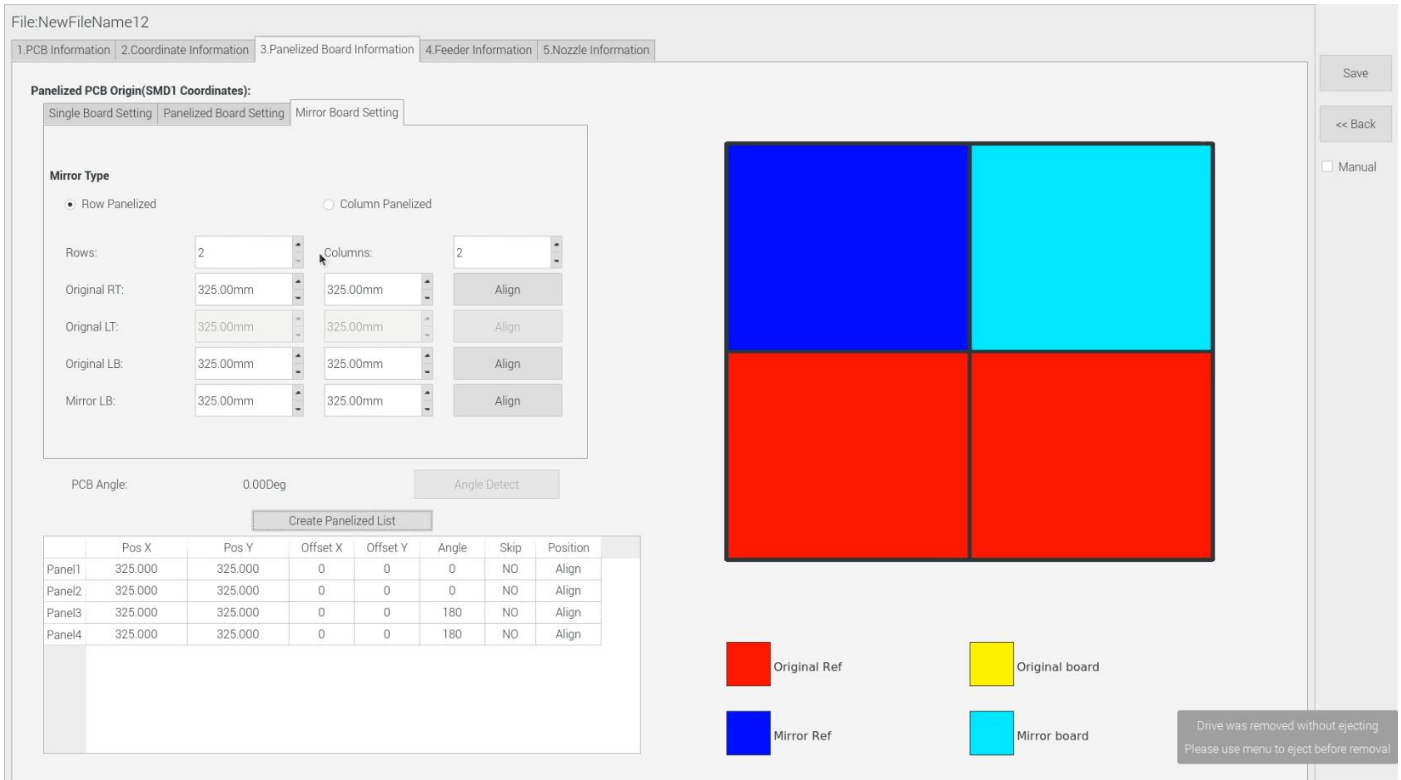
Selecting this mode, you need to enter the **row** and **column**. They are determined by the positioning of PCB on working area. The direction along the rails is the X , the direction perpendicular to the rail is Y , then please enter data in the row and column.

The data of “**Left Bottom**” is collected according to first component in the component list of programming file. Press “align” and find one component on the left-most bottom panel, then align the center of this component. Click save, the information will be saved.

The data of “**Left Top**”, press “align” and find the same component on the left top panel which corresponding to that on the Left bottom, then align the center of this component. Click save, the information will be saved.

The data of “**Right Top**”, press “align” and find the same component on the right top panel which corresponding to that on the Left bottom, then align the center of this component. Click save, the information will be saved.

3. Mirror Board Setting



The steps of the Mirror Board Setting are similar with the Panelized board, but need pay some attention to several points below:

Mirror board includes row panelized and column panelized:

Row panelized: several same PCBs are arranged in horizontal direction (X), and the nearby rows are mirrored.

Column panelized: several same PCBs are arranged in vertical direction (Y), and the nearby columns are mirrored.

Panelized Board Row and Column:

The direction along the rails is the X axis ,the direction perpendicular to the rail is Y, then please enter related qty data in the row and column.

Please refer to the data collecting method of each position information as following:

The data collection in the upper right corner of the original board is determined according to the first component in the placement list. In the "lock" in the upper right corner of the original board, first find the upper right PCB of the original board in the entire panel, and then find the Align the center of the first component in the placement list (such as R1), and click "Save and Return".

Data collection in the upper left corner of the original board, in the locked page, find the upper left component of the original board in the panel, find the same component as the upper right corner (such as R1), after aligning the center of the component, Click "Save and Return".

Data collection in the lower left corner of the original board, in the locked page, find the lower left panel of the original board in the entire panel, find the same component as the upper right corner (such as R1), align the center of the component, and click "Save and return".

Data collection in the lower left corner of the mirror board. On the lock interface, find the lower left board of the mirror board in the entire panel, find the same component as the upper right corner (such as R1), align the center of the component, and click "Save and return".

After these few settings are completed, you can click to generate the panelized list, and you can see all

the information of the first component of the mirror boards in the list, and you can still confirm the position by "align".

Note: After the first component(SMD1) is set up, need to click ‘create panelized board’. Could click Align behind each panel to double check the position of the SMD1 positions.

6.2 Create Panelized List

After setting up the SMD1 positions no matter in which PCB types, we need to click “create panelized list”. The panelized list will be generated accordingly in the blank. You can also double-confirm each position by clicking “Align”. Note: The angel difference between original and mirror board is 180 degree, original board is 0 degree, mirror is 180 degree.

Create Panelized List							
	Pos X	Pos Y	Offset X	Offset Y	Angle	Skip	Position
Panel1	423.170	115.150	0	0	0	NO	Align
Panel2	615.250	115.380	0	0	0	NO	Align
Panel3	423.290	160.110	0	0	0	NO	Align
Panel4	615.370	160.340	0	0	0	NO	Align

Skip selections:

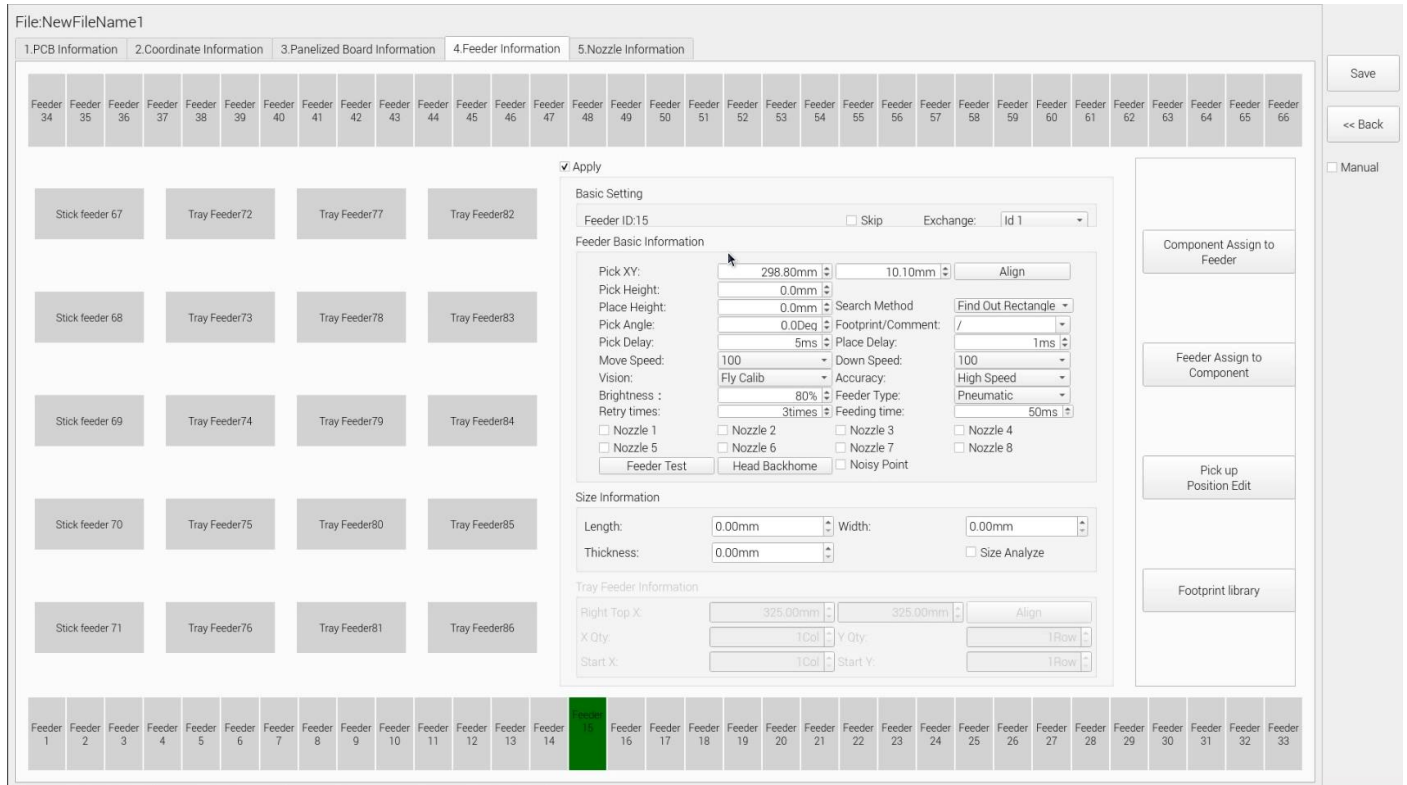
Yes: For the block component corresponding to the number entered in the panel number (edit box), if no placement operation will be performed, then select “Yes” in the drop-down list.

No: For the block component corresponding to the number entered in the panel number (edit box), if perform placement operation, then select ‘No’ in the drop-down list.

Recognition: Used for bad board detection. The current bad board detection function is still under development and cannot be used yet.

7. Feeder Information

All components' setting on this interface, such as nozzle selecting, feeder setting, pick up position edit, adjustment setting, and others components' setting need to be finished here. We can see that No.1-33stack on bottom line, No.34-66 stack on top line, No. 67-71 are for vibration feeders, and No.72-86 are for IC trays. According to the actual feeder width, the feeder quantity will be reduced.

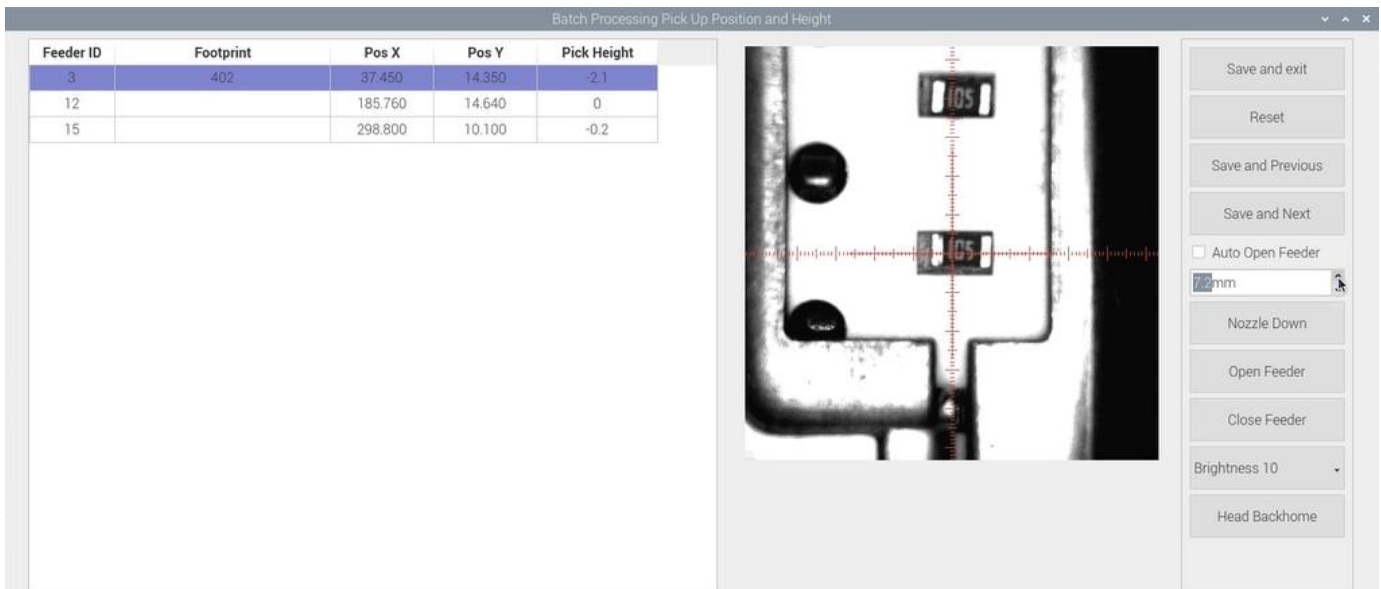


7.1 Feeder Basic Information

Component Assign to Feeder: After complete component information setting, click 'Component Assign to Feeder', the setting information will be assigned to each feeder automatically.

Feeder Assign to Component: After complete stack information and nozzle setting, click 'Feeder Assign to Component', all information will update to the component list automatically.

Pickup Position Edit: Press this button, it will show below:



please select one feeder to start setting (default start from the first assigned stack), at the same time, a real-time image will be showed as right side. Please set the red cross to the component center (generally if the feeder is in off condition, red cross will be at the edge of feeder’s tape cover), click “save and next” until all be set well and there will be beep sound as a warning, then click “save and exit”to finish it. After that, you can select any feeder’s pick position as a test. While setting the pick position, the function of “Feeder open”/ “Feeder close” can help setting the cross position more conveniently.

Footprint library: The component’s information is saved in the footprint library,including name, length, width,height, edge, pitch etc. Please note the detailed information for the IC is necessary. Press “Add” button to add a new footprint into the library; For footprints not required, please directly select them and press “Delete” button to move them. Save the setting before exit.

7.2 Feeder Settings

The default settings are grey and inactive. Select a feeder, click “Apply” to active the settings, such as feeder exchange, feeder, nozzle, IC tray feeder etc. The setting sequence is: tape reel/vibration/IC tray feeder→ Feeder basic information→ Nozzle.

This is to set up all the feeders information. Select one feeder, and tick the ‘apply’ button, then you could start with feeder settings. You have to setup the feeder basic information, nozzles information, IC tray information and so on.

Skip

Once selected, all components in this feeder will be skipped.

Feeder exchange

This function can be used if any feeders was installed at wrong or inappropriate position.

Pick XY

Align the first component position in the feeder as picture below, which is Mark camera align the component central position, then click ”save and back”, the well-saved position’s X/Y coordinates will be automatically show up as fig. (P.S.pick position can be set either by Align Pick XY one by one or by the Pick up Position Edit. Pick up Position Edit is more convenient).

Apply

Basic Setting
Feeder ID: Skip Exchange:

Feeder Basic Information

Pick XY:

Pick Height:

Place Height: Search Method:

Pick Angle: Footprint/Comment:

Pick Delay: Place Delay:

Move Speed: Down Speed:

Vision: Accuracy:

Brightness: Feeder Type:

Retry times: Feeding time:

Nozzle 1 Nozzle 2 Nozzle 3 Nozzle 4

Nozzle 5 Nozzle 6 Nozzle 7 Nozzle 8

Noisy Point

Size Information

Length: Width:

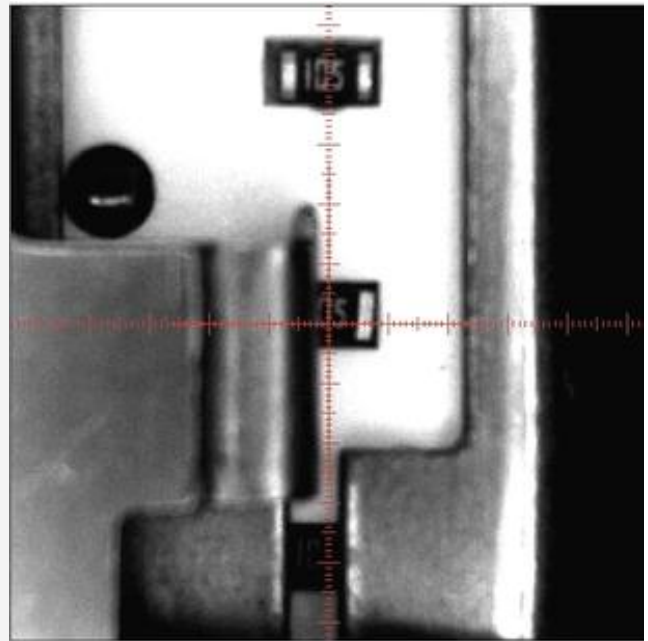
Thickness: Size Analyze

Tray Feeder Information

Right Top X:

X Qty: Y Qty:

Start X: Start Y:



Pick Angle

Default value is 0°, if any special need, you can modify this angle to change the component's placement direction. Special attention for some chips with direction requirement, such as LED red/green, diode, IC etc.

Footprint/ Comment

Footprint refers to the footprint name like 0603, 0805, 1206 etc., comment refers to component data like 10K, 75ohm, etc.

Pick Height

The height between nozzles to the components' surface on tape feeders; or nozzles to component surface on the special feeders like IC trays.

How to check pick height for the tape feeders:

1. Click Pickup Position Edit in Feeder Information tab, choosing the height value, and click nozzle down (if the feeder is closed, after click nozzle down, the feeder will open), then manually check if the nozzle could reach the component. Adjustment can be applied according to the test.
2. Go to XY movement interface in the Manual Test page, select Nozzle #1-#8, please lock the position and enter a pick height before clicking Pick test to check if the pick height is appropriate. P.S. when you doing pick test in the interface of Batch processing pick up position and height, the feeder won't open automatically, please select the upper component to do pick height test.

How to check pick height for the special feeders:

3. Go to XY movement interface in the Manual Test page, use the fiducial camera to lock the position of a certain component in the tray, and the alignment method is switched to the nozzle. At this time, enter a certain height value in the input box, and then click the suction nozzle to test the downward direction of the mouse. Don't let go of the mouse, observe Check whether the set pick-up height is reasonable, and then make fine adjustments. When the nozzle just touches the components of the tray component, the value -0.2 at this time is the pickup height.

Place Height

Need to enter the value according to your experience. For the small caps, we usually use 0.2mm. Need to do more adjustments for special components.

Please forward the PCB to the track 2 position(mounting area) and lock the PCB. Check the height from the nozzle to the track surface. (after locking the position of the pcb board, click to switch to nozzle 1) Enter a value in the input box (you can enter a positive value first) click the nozzle with the mouse to test the downward direction, please do not release the mouse, you can see where the current downward direction of the nozzle is, whether it is too high or too low, and then fine-tune the input value until the nozzle just pressed onto the PCB board. Use a vernier caliper to measure the thickness of the component, and calculate the height of the paste based on the above data.

Search Method

Identify the optional component recognition algorithm to find the center point of the rectangle components, and the drop-down menu provides find out rectangle.

Pick delay

For special components like large IC and large capacitor and small chips, it's better to set some long time delay on the pick delay to make sure nozzle can pick up them stably.

Place delay

For special components like large IC and large capacitor, it's better to set some long time delay to make sure nozzle can still suck the component stably during the movement to place on the board.

Move speed

It is used to control the head movement speed, generally just keep default will be ok. It is need be changed slower while doing some pick test.

Down speed

It is used to control the nozzle head Z-axis downward speed (Special notice: for lead pitch less than 0.5mm ICs, please set this to a lower speed).

Vision

Referring to the vision alignment methods. Against component to choose applicable vision method.

For resistor or capacitors, please select **Fly calibration**.

For component which doesn't require higher precision but higher speed, you can select **No action**.

For ICs, you can select **IC calibration** or **Big IC calibration** according to different IC sizes. The differences between IC calib and Big IC calib is that IC calib is one shot recognition; Big IC calib is separately taking photos for IC's four corners. So, if the IC size more than 27mm, please directly select big IC correction method. For **IC Rotate calibration**, the nozzle picks up IC firstly, then rotates to the set angle and moves to place it on the PCB.

Accuracy

Generally normal resistor/capacitor is default as high speed mode, do not need to modify it; For IC or very small components, please select high accuracy mode.

Brightness

It refers to the brightness of component recognition (after be picked up) in assembly procedure. The same footprint's brightness varies in different machines, so we can't provide a recommended brightness. During setup, please use size measurement function to adjust the brightness until the components are well recognized.

Feeder type

There are pneumatic and electric feeders.

Retry time

The default value before is 3 times, you could set it to one or two time for some expensive parts to avoid wastes.

Feeding time

Add feeding time for these components can't be fed in right position during default feeding time.

Noisy Point

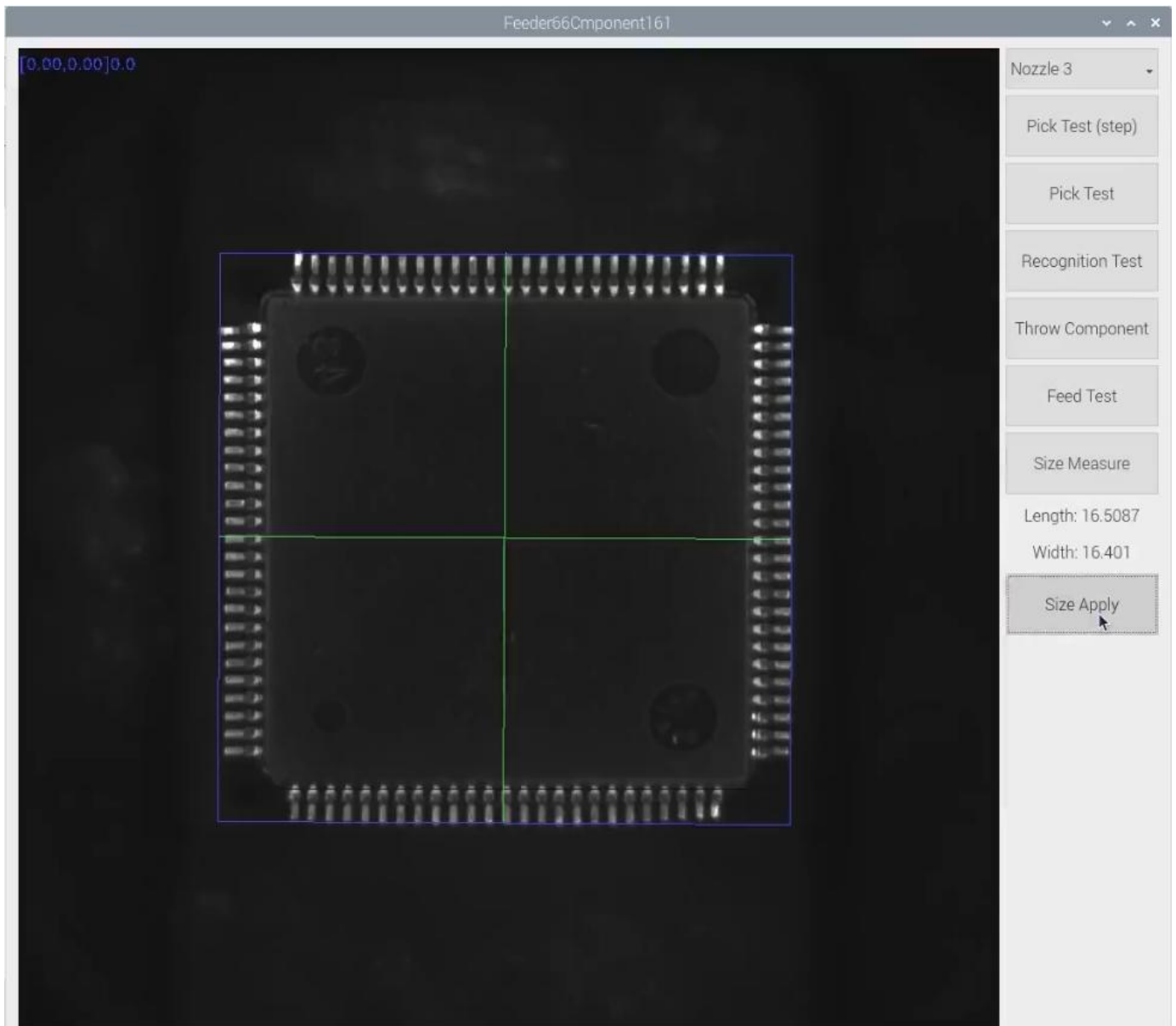
During the component recognition process, there might be some disturbing points or bright spots which could interfere the recognition effects, and cause the component throw. Tick this button, and select proper pixel value, together with adjusting the Brightness, it could achieve better recognition pictures. After setting up the pixel value of the noisy point and the brightness, please go on doing the Feeder Test, and do the Recognition Test to see if the components are recognized well or not. If the recognition images are stable, then the values are set well.

Nozzle

You can select one or several nozzles for the same feeder according to actual demand. Once selected, they'll be automatically assigned to each feeder. Notice: for feeders near four corners, some nozzles can't reach the edge feeders, and the nozzle selection is limited.

Feeder Test

If you're not sure which nozzle could reach the feeder, please click "Feeder Test" button under the nozzle selection part. It will pop out below, you can test which nozzle is available to pick up component from this selected feeder. Details for each button:



Nozzle: Select the nozzle you want to test

Pick Test(Step): click Step button after nozzles are selected→ the nozzle moves to the feeder→feeder cover opens → the nozzle moves downwards to pick up component →photograph→ throw component. This could help the user to check if the pick position or the pick height is correct. If pick fails, then please adjust parameters in feeder basic information.

Pick Test: after select the nozzle, click to do pick test, the head will move to feeder position and finish the pick up step without any pause.

Recognition Test: After clicking Pick test, the component will be picked up. Then click Recognition test to check if the component can be recognized correctly with the selected recognize method. If the component is not well recognized , adjustment can be applied to solve the issue.

Feed Test: feeding component, this is used to test if the feeder could feed components smoothly.

Size Measure: after setting up the pickup position, pick height and nozzle, click Size Measurement, the machine will measure the length and width of component according to the recognized photo, if the dimension is correct, click to save the the data.

Size Apply: If you input the length and width of the component,the image taken by flying camera will be

identified and recognized with the corresponding pixel. **Note: For special thick component, you must input the thickness!** User can choose whether to click “open size recognition” according to their own requirement. If “open size recognition” is clicked, the machine will throw the component and pick again when working if the component size is not in corresponding with setting size information.

Size Information

After entering the length and width, the component will be identified by laser camera. For those tall components, please enter the thickness. **Size Analyze** is optional, once it's ticked, if the components aren't within size offset tolerance, machine will throw the component and retry to pick up components. 25% tolerance if the chip size is below 2mm, +/-1mm tolerance if above 2mm.



The screenshot shows a control panel titled "Size Information". It contains three input fields: "Length:" with a value of "1.48mm", "Width:" with a value of "0.83mm", and "Thickness:" with a value of "0.80mm". Each field has a small up/down arrow icon on its right side. To the right of the "Thickness" field is a checkbox labeled "Size Analyze" which is checked.

IC Tray Feeder Information

It is used to set IC tray package component's pick position.



The screenshot shows a control panel titled "Tray Feeder Information". It contains several input fields and a button: "Right Top X:" with a value of "1.00mm", "Right Top Y:" with a value of "1.00mm", and an "Align" button; "X Qty:" with a value of "2Col", "Y Qty:" with a value of "2Row"; "Start X:" with a value of "1Col", and "Start Y:" with a value of "1Row". Each field has a small up/down arrow icon on its right side.

Right top XY: it refers to align the farthest component on the tray (generally take the component at right top as the final one on the tray, and take the component at left bottom position as the first one)

X qty: it refers to how many components in X direction

Y qty: it refers to how many components in Y direction

Start X, Start Y: It refers to the first IC in X/Y direction if the tray is in full package; If some ICs have been used which cause the tray is not full, you can directly set the exact position as actual situation, start X will be the location of its actual column and start Y will be its actual location of row.

After finishing above feeder settings, click **Component Assign to Feeder**, then these changes will be applied into Coordinate Information. Click to save it.

8. Nozzle Information

Below records the nozzle type of nozzle No.1-No.8. When replacing the nozzle, just replace the nozzle according to the file recorded nozzle type.

File:NewFileName1

1.PCB Information 2.Coordinate Information 3.Panelized Board Information 4.Feeder Information 5.Nozzle Information

NozzleID	Nozzle Type	Disabled	
Nozzle1	1	CN065	<input type="checkbox"/>
Nozzle2	2	CN065	<input type="checkbox"/>
Nozzle3	3	CN065	<input type="checkbox"/>
Nozzle4	4	CN065	<input type="checkbox"/>
Nozzle5	5	CN065	<input type="checkbox"/>
Nozzle6	6	CN065	<input type="checkbox"/>
Nozzle7	7	CN065	<input type="checkbox"/>
Nozzle8	8	CN065	<input type="checkbox"/>

Save

<< Back

Manual

9. Mounting Interface

Choose the programmed file in file listed interface, click “Mount”, it will go into assembly interface as below:

File: test Count1 Version: Neoden10 V8.1.5.2

Section 1
Speed(60%):
Throw : 0 Rate: 0% Statistics Start

Panelize board :			component list:								
Component	Place	Place	Feeder	Comment	Footprint	Designator	Nozzle	Pos X	Pos Y	Angle	Place
7	0201/10K	Panel1	7	10K	0201	R1	1	24.000	22.000	0	▼
8	0402/10K	Panel2	8	10K	0402	R25	2	27.000	22.000	0	▼
10	0805/10K		7	10K	0201	R2	3	23.860	23.040	15	▼
11	0603/10K		8	10K	0402	R26	4	26.760	23.810	15	▼
72	STM-LQFP10...		11	10K	0603	R49	5	31.000	22.000	0	▼
73	STM-LQFP144...		10	10K	0805	R73	6	36.000	22.000	0	▼
74	STM-LQFP176...		11	10K	0603	R50	7	30.630	24.850	15	▼
			7	10K	0201	R3	1	23.460	24.000	30	▼
			8	10K	0402	R27	2	26.060	25.500	30	▼
			7	10K	0201	R4	3	22.830	24.830	45	▼
			8	10K	0402	R28	4	24.950	26.950	45	▼
			11	10K	0603	R51	5	29.530	27.500	30	▼
			10	10K	0805	R74	6	35.450	26.140	15	▼
			11	10K	0603	R52	7	27.780	29.780	45	▼
			7	10K	0201	R5	1	22.000	25.460	60	▼
			8	10K	0402	R29	2	23.500	28.060	60	▼
			7	10K	0201	R6	3	21.040	25.860	75	▼
			8	10K	0402	R30	4	21.810	28.760	75	▼
			11	10K	0603	R53	5	25.500	31.530	60	▼

Prev Next View

 Standard placement
 Place selected components
 Place selected feeders

display 1

display 2

display 2

display 4

display 5

display 6

display 7

display 8

9.1 Mounting Interface Introduction

On the very left column is feeder info, panelized in the middle, and component list on the right. Following the highlight blue will get a real-time assembly situation. On right top is the current assembly speed, you can drag the scroll bar to change it and the max is 100%; **Note, only with two covers on the front and back of the machine could the speed be adjusted.**

Throw rate will be showed below the speed. You could check each feeder’s component pick failure rate then get which kind of component is easily pick failure, find solution to solve it.

Log shows some information like rate of throw component , current average speed and how many pieces components have been assembled under the current file.

Choose different placement method

Standard placement: feeder list,chip list are already been ticked,just need click Start

File:test Count1 Version: Neoden10 V8.1.5.2

Section 1

Panelize board : component list:

Component	Place	Place	Feeder	Comment	Footprint	Designator	Nozzle	Pos X	Pos Y	Angle	Place
7	0201/10K	Panel1	7	10K	0201	R1	1	24.000	22.000	0	<input checked="" type="checkbox"/>
8	0402/10K	Panel2	8	10K	0402	R25	2	27.000	22.000	0	<input checked="" type="checkbox"/>
10	0805/10K		7	10K	0201	R2	3	23.860	23.040	15	<input checked="" type="checkbox"/>
11	0603/10K		8	10K	0402	R26	4	26.760	23.810	15	<input checked="" type="checkbox"/>
72	STM-LQFP10...		11	10K	0603	R49	5	31.000	22.000	0	<input checked="" type="checkbox"/>
73	STM-LQFP144...		10	10K	0805	R73	6	36.000	22.000	0	<input checked="" type="checkbox"/>
74	STM-LQFP176...		11	10K	0603	R50	7	30.630	24.850	15	<input checked="" type="checkbox"/>
			7	10K	0201	R3	1	23.460	24.000	30	<input checked="" type="checkbox"/>
			8	10K	0402	R27	2	26.060	25.500	30	<input checked="" type="checkbox"/>
			10	10K	0201	R4	3	22.830	24.830	45	<input checked="" type="checkbox"/>
			11	10K	0402	R28	4	24.950	26.950	45	<input checked="" type="checkbox"/>
			12	10K	0603	R51	5	29.530	27.500	30	<input checked="" type="checkbox"/>
			13	10K	0805	R74	6	35.450	26.140	15	<input checked="" type="checkbox"/>
			14	10K	0603	R52	7	27.780	29.780	45	<input checked="" type="checkbox"/>
			15	10K	0201	R5	1	22.000	25.460	60	<input checked="" type="checkbox"/>
			16	10K	0402	R29	2	23.500	28.060	60	<input checked="" type="checkbox"/>
			17	10K	0201	R6	3	21.040	25.860	75	<input checked="" type="checkbox"/>
			18	10K	0402	R30	4	21.810	28.760	75	<input checked="" type="checkbox"/>
			19	10K	0603	R3	1	23.460	24.000	30	<input checked="" type="checkbox"/>

1. select Standard placement

2. click Start

Speed(60%) Throw : 0 Rate: 0% Statistics Start

Log: Step(Enter) Stop(T) Config Exit File Edit Forward Backward

display 1 display 2 display 2 display 4 display 5 display 6 display 7 display 8

Place selected components: select the component which want to be placed in the placement list, check Mount, then select the component which want to start , click Start.

File:test Count1 Version: Neoden10 V8.1.5.2

Section 1

Panelize board : component list:

Component	Place	Place	Feeder	Comment	Footprint	Designator	Nozzle	Pos X	Pos Y	Angle	Place
7	0201/10K	Panel1	7	10K	0201	R1	1	24.000	22.000	0	<input type="checkbox"/>
8	0402/10K	Panel2	8	10K	0402	R25	2	27.000	22.000	0	<input type="checkbox"/>
10	0805/10K		7	10K	0201	R2	3	23.860	23.040	15	<input type="checkbox"/>
11	0603/10K		8	10K	0402	R26	4	26.760	23.810	15	<input type="checkbox"/>
72	STM-LQFP10...		11	10K	0603	R49	5	31.000	22.000	0	<input type="checkbox"/>
73	STM-LQFP144...		10	10K	0805	R73	6	36.000	22.000	0	<input type="checkbox"/>
74	STM-LQFP176...		11	10K	0603	R50	7	30.630	24.850	15	<input type="checkbox"/>
			7	10K	0201	R3	1	23.460	24.000	30	<input type="checkbox"/>
			8	10K	0402	R27	2	26.060	25.500	30	<input type="checkbox"/>
			10	10K	0201	R4	3	22.830	24.830	45	<input type="checkbox"/>
			11	10K	0402	R28	4	24.950	26.950	45	<input type="checkbox"/>
			12	10K	0603	R51	5	29.530	27.500	30	<input type="checkbox"/>
			13	10K	0805	R74	6	35.450	26.140	15	<input type="checkbox"/>
			14	10K	0603	R52	7	27.780	29.780	45	<input type="checkbox"/>
			15	10K	0201	R5	1	22.000	25.460	60	<input type="checkbox"/>
			16	10K	0402	R29	2	23.500	28.060	60	<input type="checkbox"/>
			17	10K	0201	R6	3	21.040	25.860	75	<input type="checkbox"/>
			18	10K	0402	R30	4	21.810	28.760	75	<input type="checkbox"/>
			19	10K	0603	R3	1	23.460	24.000	30	<input type="checkbox"/>

1. select Place selected components

2. select the component

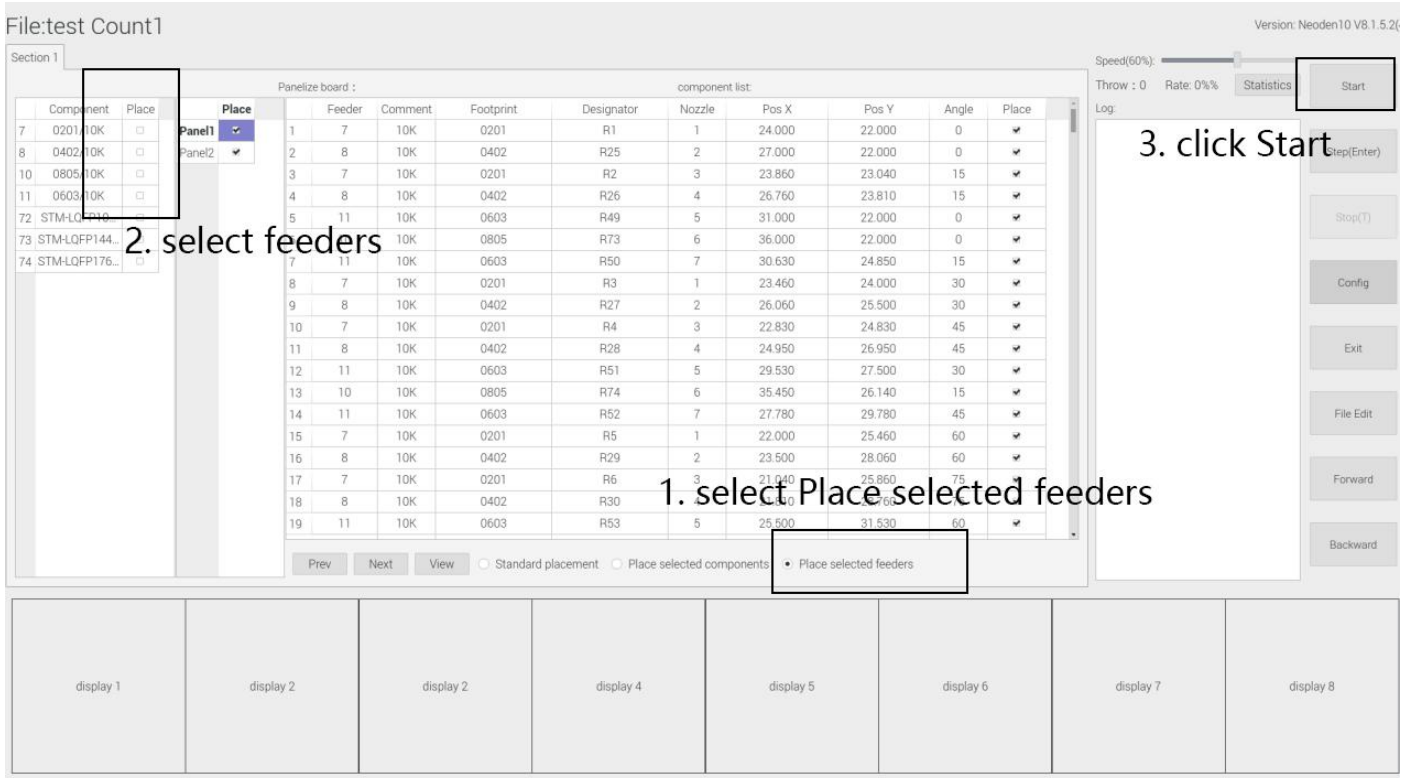
3. click Start

Speed(60%) Throw : 0 Rate: 0% Statistics Start

Log: Step(Enter) Stop(T) Config Exit File Edit Forward Backward

display 1 display 2 display 2 display 4 display 5 display 6 display 7 display 8

Place selected feeder: Tick the feeder that you want to mount with.



View: After finish assembly work, users can select the corresponding components in the chip list, click View, photo 1 display the mounting situation of this component.

The bottom side display windows are real-time feedback for component recognition.

Right side buttons introduction:

Start: Need to put the PCB on the track 1 position and then click Start to start the assembly procedure.

Step(enter): operation for each single assembly procedure. Could see clearly of each steps. Very useful when some misplacement happens, could be used to find out where is problem.

Stop: Stop current assembly work.

Exit: once mounting work finished, please directly click this button and back to home interface.

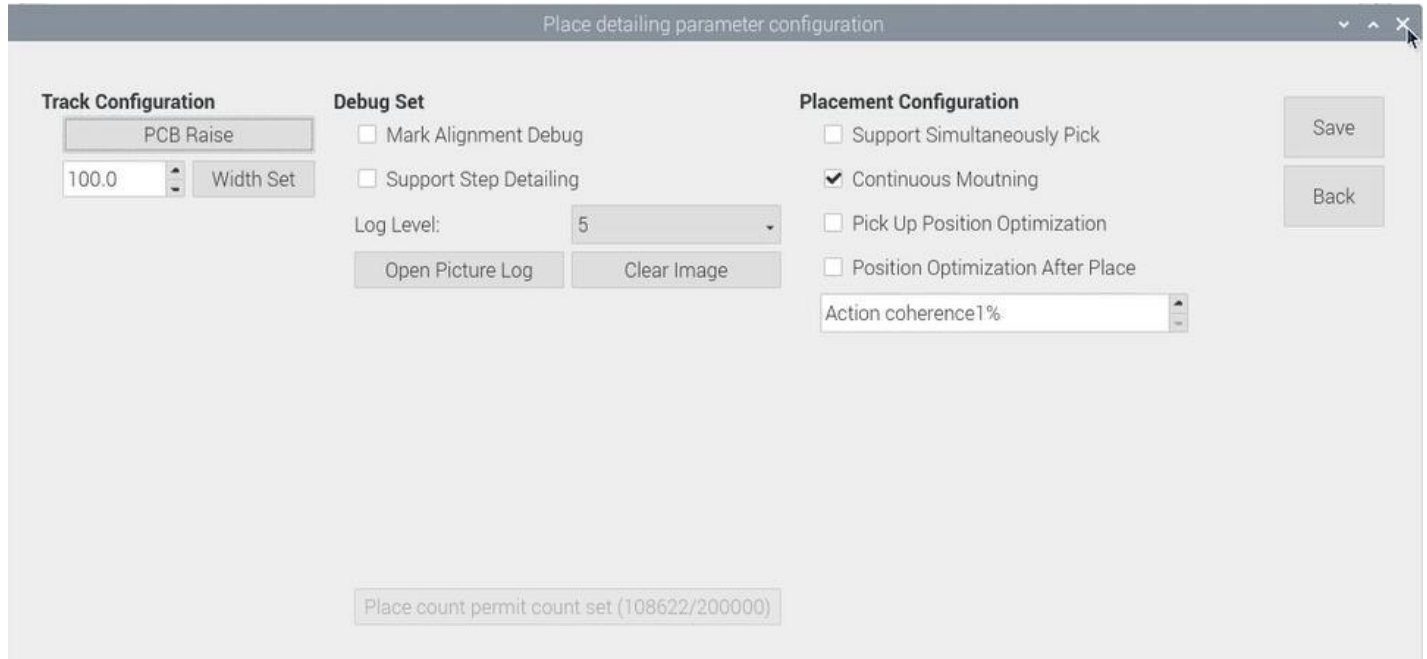
File Edit: In the process of mounting, if nozzle can't pick the component l for many times or big offset, Click Stop, analyze the related reason, and then click the File Edit , edit file without exiting the mounting interface, after finish modification,click Save and back to mounting interface

Forward, to let the PCB go inside the machine.

Backward, to let the PCB go outside the machine. If the PCB is already in the machine, need to click backward to exit the PCB, then put it on the track 1 position and then click Start.

9.2 Configuration Interface Introduction

Press Config, a detailed configuration will pop out as below



Track configuration

the function of PCB Raise and Width Set are totally same as that in PCB Information interface.

Debug Set:

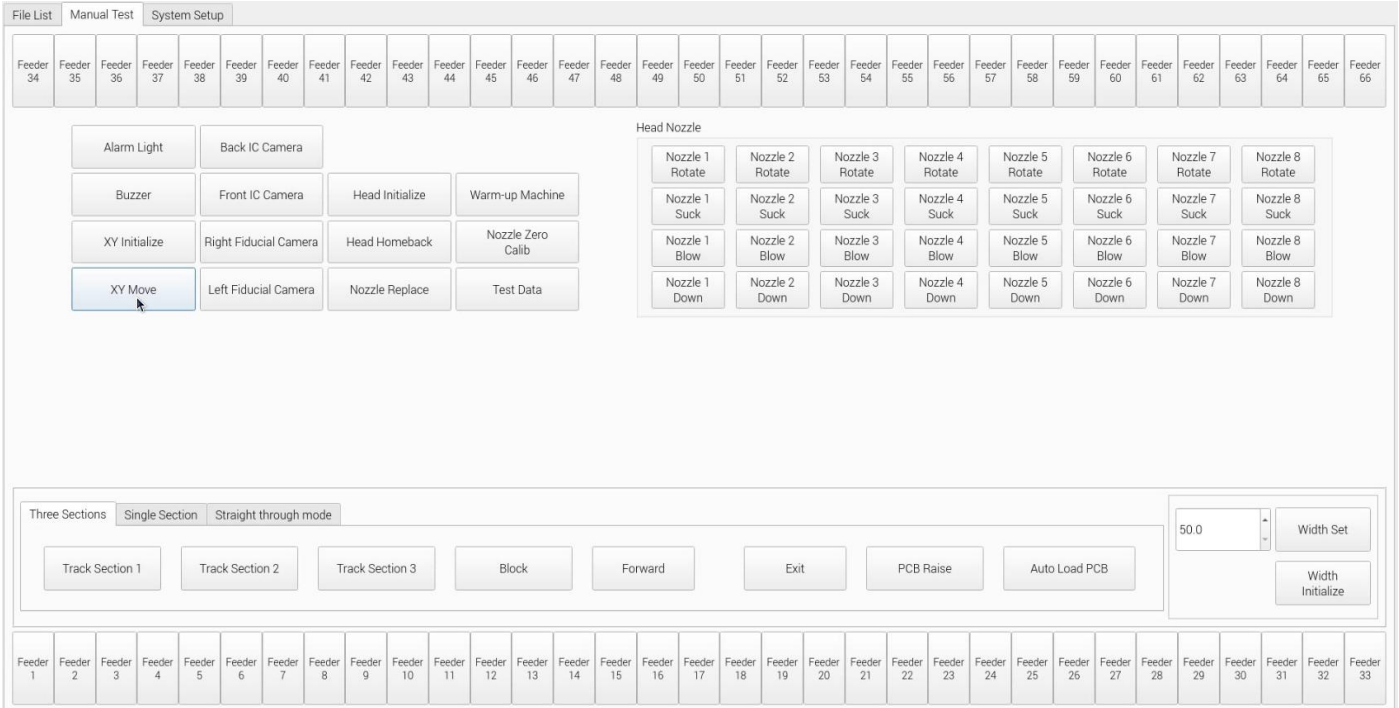
- (1)Support step detailing: once this is clicked, every time you click “Step”, the machine will only execute one command. This is strongly recommended for the first trial assembly procedure after the programming file is finished.
- (2)Open picture log: after pressing this button, the file of stocking recognition photos will be opened, from which recognition details of components can be checked.

Placement configuration:

- (1)Support simultaneously pick: once this is clicked, the nozzles with same pick height will lower down to pick components at the same time, which will greatly improve placement speed (It is recommended for component whose size is bigger than that of 0603).
- (2) Continuous mounting: this is for PCB continuously feeding to realize continuous automatic assembly operation.
- (3)Pick up position optimization: once this is clicked, nozzle head can automatically optimize the pick position when picking components(It is recommended only for small components).
- (4)Position optimization after place: if this function is selected in the first time, it will directly come to position correction interface after placement is finished. User needs to correct the position according to the actual placement situation.After the correction is completed, machine will place the components according to the corrected position when the placement is performed again.
- (5)action coherence: larger percentage, higher speed of the mounting process. lower speed is suggested to mount the big ICs, and very small components, like 0201.

10. Manual Test

Before programming, perform a manual test at first to debug whether the machine can work normally.



10.1 Basic Information

In this interface, you could test the function of each parts of the machine.

Feeder Test from No.1-No.66: after installing the tape reel on feeder, click the feeder to test its feeding function.

Alarm light: click this button to test if the light could work correctly, the color should change from red, green to yellow in sequence.

Buzzer: click this button, the buzzer beeps.

XY initialize: click this button to have XY back to zero.

XY Move: it's to move to a specified position or get the current coordinate. Click this button to enter a vision interface. The movement modes are optional. Use the crosshair on the left vision interface to move the placement head.

Front/Rear IC Camera: it's to test the photograph function. Click this button, front IC camera will take a photo and the image above front IC camera will be displayed.

Right Fiducial Camera, Left Fiducial Camera: it's to test the photograph function. Click this button, the corresponding mark camera will take a photo and the image below the corresponding mark camera will be displayed.

Head Initialize: head initialization can be executed before mounting; all nozzles will move to the initial position.

Warm up machine: it will test the machine functions when you click it. It will last for 10 minutes if you do not set a warm up time. We suggest to do a machine warming up if a long time no using.

Nozzle Zero Calib: it's to adjust the height of the nozzles to the same height. Adjustment method:

1.Preparation tools: 1pc of A4 paper, 1pc of standard nozzle. Steps: 1.Visually confirm whether there is a nozzle on the placement head, click “nozzle height calib”; 2.Lock the nozzle position to above the track(after selecting the position and nozzle No.1’s alignment method, save it). Select the corresponding nozzle and click the up button and down button on the keyboard to to adjust the height of nozzle to make sure that the nozzle just presses on the upper plane of the track after the nozzle is lowered. After the adjustment is complete, just save it.

Head Homeback: click to move the nozzles back to original left top position.

Nozzle Replace: click to replace nozzles, the head will move to its position for easier replacement.

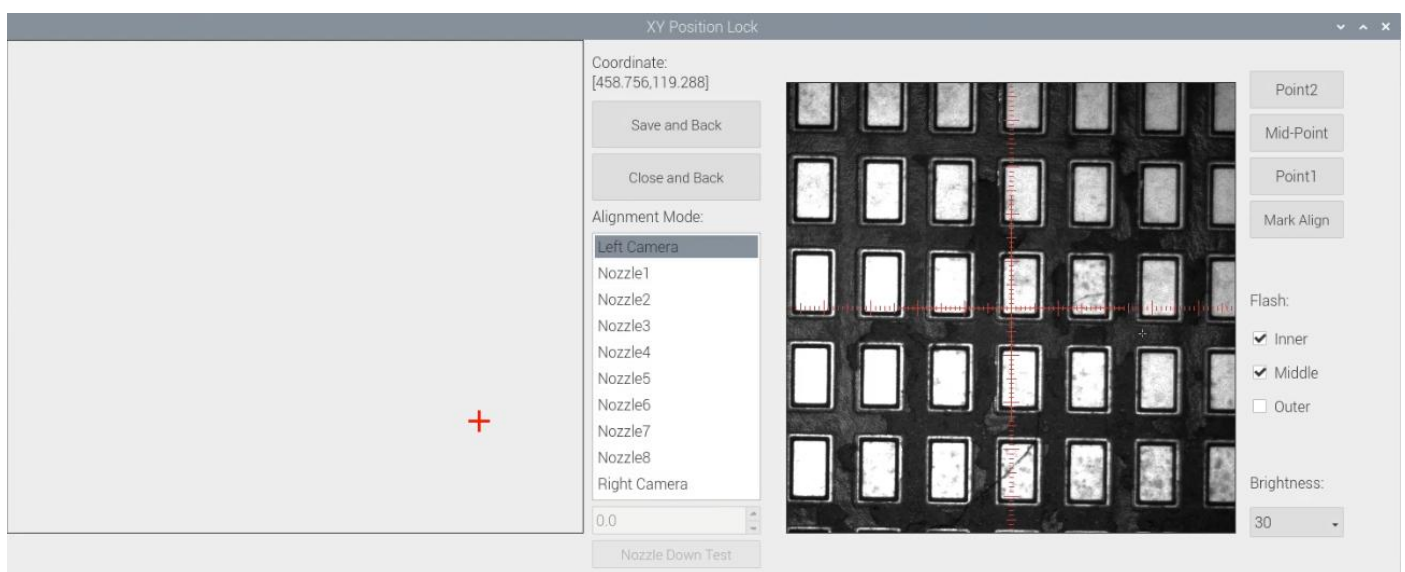
Head Nozzle: click to test rotation, suction, blow and moving down functions of nozzle No.1-No.8.

Width Initialize: initialize the width of rails back to zero.

Width Set: after the initialization of rails width, enter the expected width, click Width Set, the rails be widened accordingly.

Auto load PCB: there are three track mode-three sections, single section, straight through mode. Click the option of auto load PCB, the track will enter the working mode. Put one PCB on the entrance of the track, it will be stopped by the PCB stopper; then click PCB raise, the PCB will be release and move to the end of track automatically.

10.2 XY Position Lock Interface



Save and back: After align the center of components,click “save and back”to save the date.

Close and Back: Refer to exit the current interface.

Align method : Include left mark camera,nozzle 1-8,right mark camera,choose the alignment method according to the actual situation,right side will show the real image by mark camera alignment.

Nozzle Down Test:

When Left/Right cameras are selected as the alignment mode, this function is gray and inoperable. When selecting one of nozzle 1-8, this interface turns black and can be operated. The user must first lock the position, enter a reasonable height value, and then click the nozzle down test button to measure whether the reclaiming height is reasonable. (Note: when locking the interface to test the reclaiming height of feeder, feeder will not open automatically. You can select the material above the edge of the component to measure.)

Point 1, Point 2, Mid-point:

This operation is used to select the center position of some components. For example, select " left mark

camera" as alignment mode. First select the center of the first pin of the lower left foot of the chip, click "point 1", then select the pin center of the upper right foot opposite to left 1, click "point 2", and then click the middle point. The machine will automatically calculate the center position of the chip.

Flash: outer, middle, Inner. Mark point generally select to use outer or inner,select corresponding light source according to PCB type.

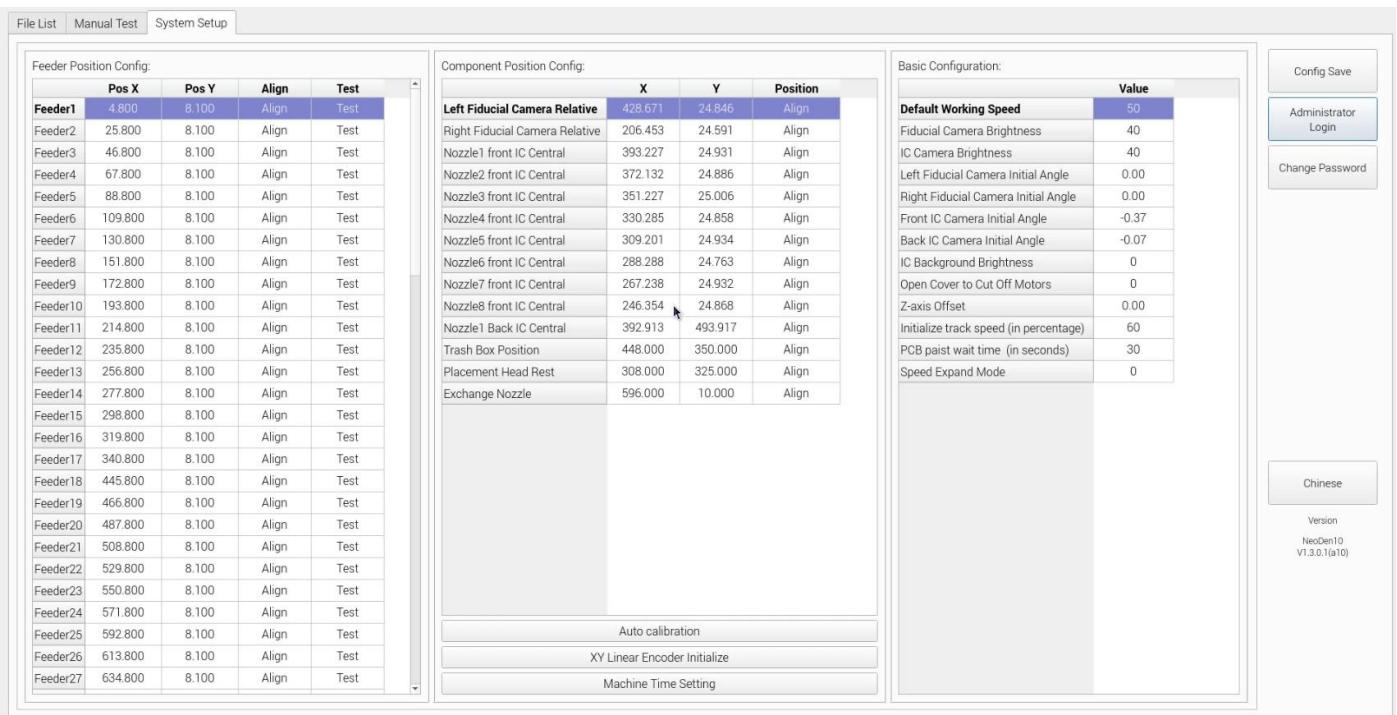
Brightness: Image recognize brightness can be adjusted on the drop-down list.

11. System Setup



Warning: this part aims at machine’s global parameter settings, any modified parameter will influence all working files, when modify this part please consider seriously.

If any revision is required, we suggest you contact our engineer to get detailed instruction first. (P.S. All parameters were set up before shipping, usually no adjustment is required.) This section will provide a brief introduction for all parameters, to get detailed adjustment instruction, please contact our technical engineer.



Feeder	Pos X	Pos Y	Align	Test
Feeder1	4.800	8.100	Align	Test
Feeder2	25.800	8.100	Align	Test
Feeder3	46.800	8.100	Align	Test
Feeder4	67.800	8.100	Align	Test
Feeder5	88.800	8.100	Align	Test
Feeder6	109.800	8.100	Align	Test
Feeder7	130.800	8.100	Align	Test
Feeder8	151.800	8.100	Align	Test
Feeder9	172.800	8.100	Align	Test
Feeder10	193.800	8.100	Align	Test
Feeder11	214.800	8.100	Align	Test
Feeder12	235.800	8.100	Align	Test
Feeder13	256.800	8.100	Align	Test
Feeder14	277.800	8.100	Align	Test
Feeder15	298.800	8.100	Align	Test
Feeder16	319.800	8.100	Align	Test
Feeder17	340.800	8.100	Align	Test
Feeder18	445.800	8.100	Align	Test
Feeder19	466.800	8.100	Align	Test
Feeder20	487.800	8.100	Align	Test
Feeder21	508.800	8.100	Align	Test
Feeder22	529.800	8.100	Align	Test
Feeder23	550.800	8.100	Align	Test
Feeder24	571.800	8.100	Align	Test
Feeder25	592.800	8.100	Align	Test
Feeder26	613.800	8.100	Align	Test
Feeder27	634.800	8.100	Align	Test

	X	Y	Position
Left Fiducial Camera Relative	428.671	24.846	Align
Right Fiducial Camera Relative	206.453	24.591	Align
Nozzle1 front IC Central	393.227	24.931	Align
Nozzle2 front IC Central	372.132	24.886	Align
Nozzle3 front IC Central	351.227	25.006	Align
Nozzle4 front IC Central	330.285	24.858	Align
Nozzle5 front IC Central	309.201	24.934	Align
Nozzle6 front IC Central	288.288	24.763	Align
Nozzle7 front IC Central	267.238	24.932	Align
Nozzle8 front IC Central	246.354	24.868	Align
Nozzle1 Back IC Central	392.913	493.917	Align
Trash Box Position	448.000	350.000	Align
Placement Head Rest	308.000	325.000	Align
Exchange Nozzle	596.000	10.000	Align

	Value
Default Working Speed	50
Fiducial Camera Brightness	40
IC Camera Brightness	40
Left Fiducial Camera Initial Angle	0.00
Right Fiducial Camera Initial Angle	0.00
Front IC Camera Initial Angle	-0.37
Back IC Camera Initial Angle	-0.07
IC Background Brightness	0
Open Cover to Cut Off Motors	0
Z-axis Offset	0.00
Initialize track speed (in percentage)	60
PCB paist wait time (in seconds)	30
Speed Expand Mode	0

The buttons on the right column:

Config save: to click Save after changing the parameters on this page.

Administrator login: to prevent any misoperation, this interface will be inactive and greys out. To make it inactive, Administrator needs to login.

Change password: before Administration login, this function is not visible. If the password needs to be changed, please login and click Change password. A window will pop out, enter the original password. Then follow steps to enter the new password. A successful window will pop out when it’s finished.

Version: the current software version will be displayed below. When any software upgrade is required, please copy the upgrade file into the subdirectory of U disk, click “software upgrade” to load it. Then follow instructions to upgrade it.

English: this machine supports Chinese and English. To convert it into English, a password is required.

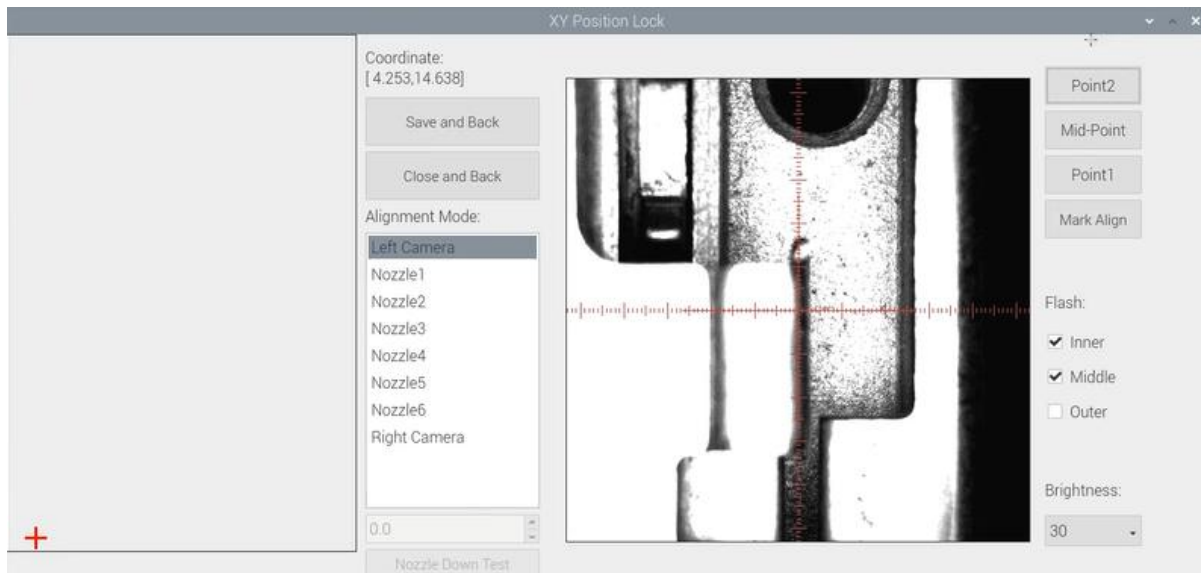
11.1 Feeder Position Config

This interface is used to setup pick offset and test feeding for each feeder.

Feeder Position Config:

	Pos X	Pos Y	Align	Test
Feeder1	4.255	14.639	Align	Test
Feeder2	20.755	14.639	Align	Test
Feeder3	37.255	14.639	Align	Test
Feeder4	53.755	14.639	Align	Test
Feeder5	70.255	14.639	Align	Test
Feeder6	86.755	14.639	Align	Test
Feeder7	103.255	14.639	Align	Test
Feeder8	119.755	14.639	Align	Test
Feeder9	136.255	14.639	Align	Test
Feeder10	152.755	14.639	Align	Test
Feeder11	169.255	14.639	Align	Test
Feeder12	185.755	14.639	Align	Test
Feeder13	289.031	14.117	Align	Test
Feeder14	305.531	14.117	Align	Test
Feeder15	322.031	14.117	Align	Test
Feeder16	338.531	14.117	Align	Test
Feeder17	355.031	14.117	Align	Test
Feeder18	371.531	14.117	Align	Test
Feeder19	388.031	14.117	Align	Test
Feeder20	404.531	14.117	Align	Test
Feeder21	421.031	14.117	Align	Test
Feeder22	437.531	14.117	Align	Test
Feeder23	454.031	14.117	Align	Test
Feeder24	470.531	14.117	Align	Test
Feeder25	1.551	523.659	Align	Test
Feeder26	18.051	523.659	Align	Test

The left column refers to feeder No., Pick X and Pick Y refer to the coordinates of pick offset. After “click to align”, this interface will be displayed. Align the center of component (edge of tablet), then save it.



11.2 Component Positions Setup

Component Position Config:

	X	Y	Position
Left Fiducial Camera Relative	428.671	24.846	Align
Right Fiducial Camera Relative	206.453	24.591	Align
Nozzle1 front IC Central	393.227	24.931	Align
Nozzle2 front IC Central	372.132	24.886	Align
Nozzle3 front IC Central	351.227	25.006	Align
Nozzle4 front IC Central	330.285	24.858	Align
Nozzle5 front IC Central	309.201	24.934	Align
Nozzle6 front IC Central	288.288	24.763	Align
Nozzle7 front IC Central	267.238	24.932	Align
Nozzle8 front IC Central	246.354	24.868	Align
Nozzle1 Back IC Central	392.913	493.917	Align
Trash Box Position	448.000	350.000	Align
Placement Head Rest	308.000	325.000	Align
Exchange Nozzle	596.000	10.000	Align

Auto calibration

XY Linear Encoder Initialize

Machine Time Setting

(note: In order to prevent misuse, this step needs to unlock the password before it can be changed. Click the administrator on the right to log in before changing it. It is recommended to make changes under the guidance of the manufacturer's engineer.)

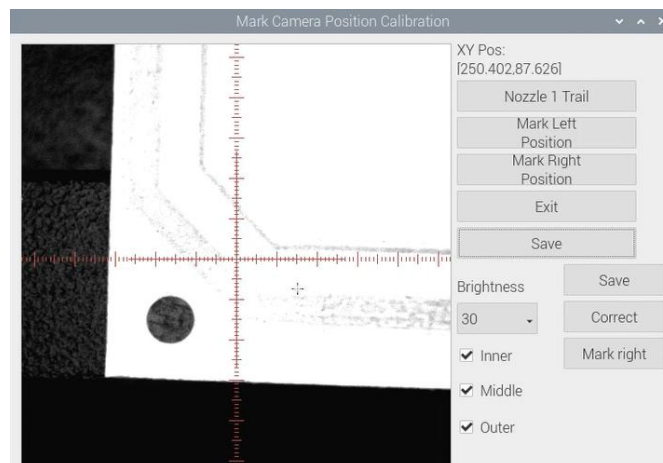
1.Introduction of Mark Camera Relative Position function:

Left Mark Camera Positioning: The left camera is used to recognize the image after leaving the mark

Right Mark Camera Positioning: The right camera is used to recognize the image after leaving the mark

(In principle, the images of left and right cameras are the same)

Mark Camera Relative Position



Stick a piece of label on the edge of rail and apply ink or ink on the nozzle;

Enter the manual test interface, click XY to move, find the position of the label paper (the position pasted on the rail surface) through the reference camera, then switch the alignment mode to "nozzle 1", and then click "close and return". After entering the factory settings, the administrator logs in first, clicks "click lock" at the relative position of the mark camera, and a prompt window pops up (do you want to leave a mark at the current position). Click Yes, and the following interface will appear. Click "nozzle 1 leave a mark" and the sticker will drop, leaving a dot. Observe the position deviation between the mark point and the center point of the red cross cursor, You can use the Red Cross to select the center position of the mark point. If the deviation position is within 10 wires, it is regarded as the completion of the mark. After the left camera is aligned, click mark to locate it right. Similarly, you can also use the cross to select the center position of the line mark point. Note: both left and right cameras shall be positioned and then saved (if the deviation is too large, the Engineer shall be contacted in time for correction)

Exit: Exit without leaving marks

Save: After the marking operation is completed and the center position of the marking point is also selected, click save to save the data.

Brightness: The brightness of the mark camera when recognizing an image, it can be adjusted in the drop-down list according to the actual situation.

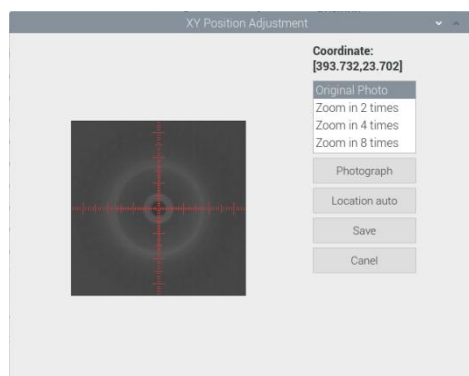
2. Nozzles and IC camera center position

Nozzle 1 front IC Central Position:

Click to align, nozzle 1 will move to front IC camera and take photos. Once the photo is displayed, to manually align the central position of nozzle with white crosshair and save the data. (note: Once the Nozzle 1 front IC Central Position, nozzle 2-8 central position will be changed based on nozzle 1.) Apply the same operation for Nozzle 2 front IC Central Position and Nozzle 8 front IC Central Position.

Nozzle 1 back IC Central Position:

Click to align, nozzle 1 will move to front IC camera and take photos. Once the photo is displayed, to manually align the central position of nozzle with white crosshair and save the data.



3. Trash Box Position:

After Administration Login, click to align the position of trash box accordingly.

4. Placement Head Reset Position

After Administration Login, click to align the position of Placement Head Reset accordingly.

5. Exchange Nozzle Position

After Administration Login, click to align the position of exchanging nozzles accordingly.

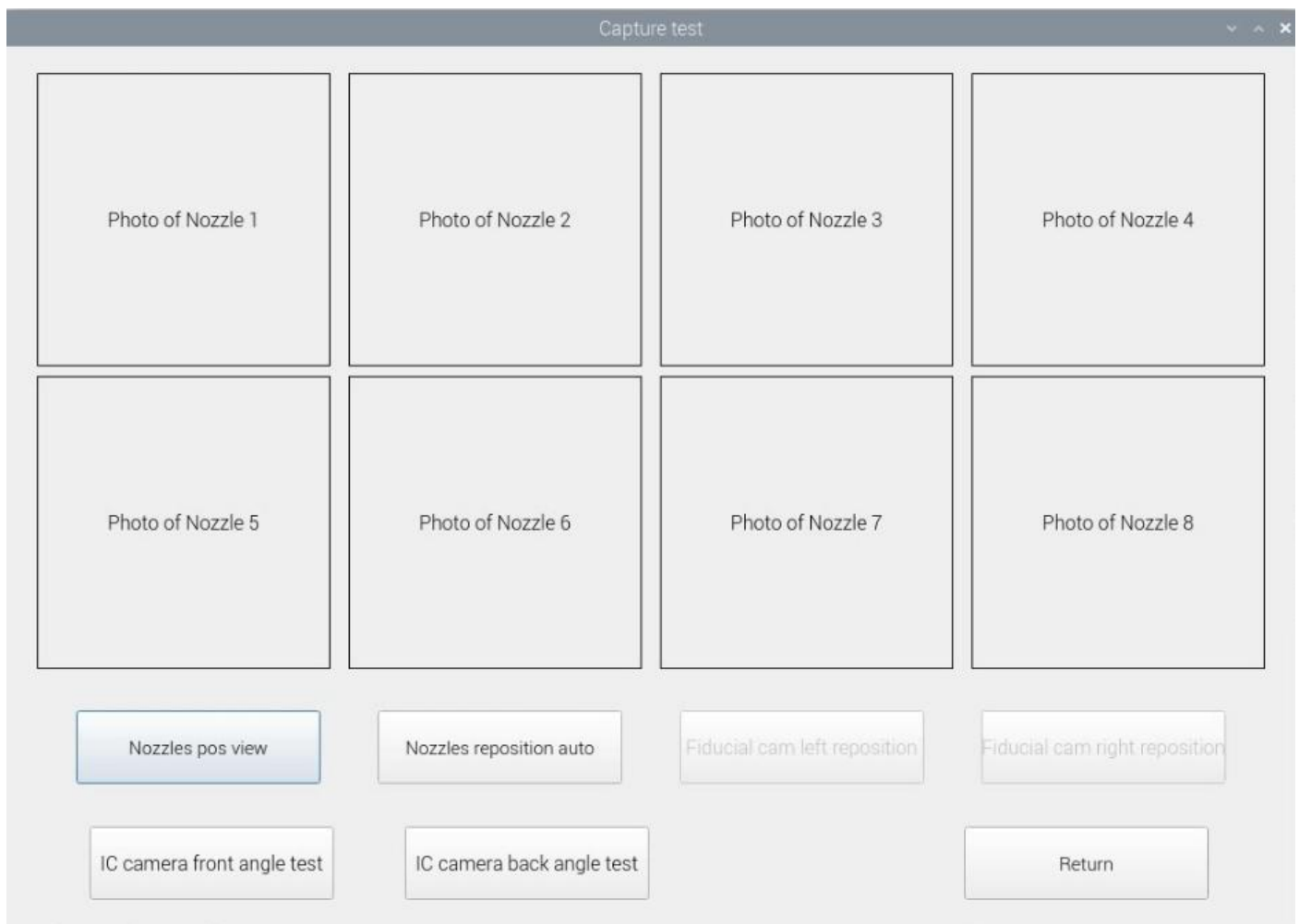
6. Automatic Calibration

This is for checking the positions of nozzle 1-6 in the center of the front IC camera. Click this button, 1-6 nozzles will act automatically and display in this interface

Automatic positioning of nozzle: It can realize the automatic positioning of nozzle and front IC camera.

Left and right mark camera positioning: this function is currently under development.

Front and rear IC camera angle: the camera may have an angle when the equipment is installed. This function can automatically measure the angle of the front IC camera to improve the mounting accuracy. Click this button, the nozzle 1 takes the mark point and acts. After the action is completed, click return, and the automatically measured data will be synchronized to the initial angle of the front IC camera in the right basic configuration.



Auto Calibration Interface

7. XY Linear Encoder Initialize



Warning: This is only need to do after the Linear was reinstalled or some mechanism changed. Please do not change it without checking with NeoDen Team.

8. **Machine time setting:** If the device time is different from the current time, you can set it here

Zhejiang Neoden Technology Co., Ltd

11.3 Basic Configuration

Basic Configuration:	
	Value
Default Working Speed	50
Fiducial Camera Brightness	40
IC Camera Brightness	40
Left Fiducial Camera Initial Angle	0.00
Right Fiducial Camera Initial Angle	0.00
Front IC Camera Initial Angle	-0.37
Back IC Camera Initial Angle	-0.07
IC Background Brightness	0
Open Cover to Cut Off Motors	0
Z-axis Offset	0.00
Initialize track speed (in percentage)	60
PCB paist wait time (in seconds)	30
Speed Expand Mode	0

Default Working Speed: this is adopted by the placement speed in the mounting interface

Mark Camera Brightness and IC Camera Brightness: they are the default value when coming out from the factory. The default value for Mark Camera Brightness is 30, and for IC Camera Brightness is 40. They can be adjusted according to the real situation.

Left Mark Camera Initial Angle, Right Mark Camera Initial Angle, Front IC Camera Initial Angle and Back IC Camera Initial Angle:



Warning: the values are already set up before shipping, no extra adjustment is required. There is a risk to lead to malfunctional condition, please kindly contact technical engineer before

Track Feeding PCB Duration(S): track forward to the conveyor and sending the signal, the duration of waiting for the PCB feeding

Open Cover to Cut Off Motors: this is to prevent any body damage during picking and placing. if set value 1, in the mounting process when open the cover, the machine will turn to Step mode to do the mounting, due to the safety consideration; if set value 0, and open the cover in the mounting process, the machine continues mounting but with lower speed as 20.

PCB Movement Delay(ms): it refers to the delay that the sensor ready to squeeze the PCB after PCB feeding and stopped by the stopper block and stops above the sensor. If the PCB feeds into the machine but the squeeze speed is too slow, the track belt will keep rotating and cause belt wear. Customer needs to adjust this value together with Track speed to make the PCB squeezed once it feeds to the stopper block.

12. First trial and test

12.1 First trial

Program first dry run

Usually we would suggest you to have a dry run (no components are loaded) before production test. After it goes smoothly, you can start to produce few boards.

First production test

1. Make a programming file
2. Test the file to pick and place components to finish one board.

Component Inspection

Inspection items

- Check if the specification, direction, polarity of components is aligned with what they should be.
- Whether the components are damaged or the pins are distorted.
- Whether the component is off beyond allowance.

The inspection methods vary from the equipment that you have.

Except visual inspection, all of amplifier, microscope, online or offline AOI equipment can be applied if the pitch of IC is quite small to check.

12.2 Inspection Standard

Please follow SOP to do inspection or any other general standards (IPC Standard and SJ/T10670-1995 SMT General Technical Requirements). Adjust the programming file according to the placement effect after the first production test.

1. If there are any specification, direction and polarity issues, please do the adjustment according to the process file.
2. If there is any deviations of the chip placement, please do the adjustment by following two methods:
 - (1) If the placement effects of all components are off in the same direction, it would be the fiducial issues. Please adjust the coordinates of fiducials according to its value of deviation.
 - (2) If there are several components off beyond allowance, you'd better adjust their coordinates on working file with down-looking camera. If there are couple of issues occur during test, some other points need to be considered.
3. Frequent pickup failure. Some suggestions are listed below
 - (1) The pick height is inappropriate, please revise the value after an inspection or a pick-test
 - (2) The pick offset needs an adjustment, it should be aligned with the center of component reel slot rather than that of component.
 - (3) Due to peel strength or installation issue of wasted film, the film on tape won't be peeled completely
 - (4) The nozzle was blocked
 - (5) The nozzle is damaged or has a crack
 - (6) The size issue of nozzle would cause air leakage or insufficient suction
 - (7) The air hose is blocked or has a leakage problem, and even the pump has an issue.
4. Frequently throwing components. Some suggestions are listed below,
 - (1) Up-looking camera can't take a clear picture of component due to brightness issue for example
 - (2) The pins are distorted

- (3) The size or shape isn't aligned with that in "Footprint library"
- (4) The size of nozzle is inappropriate or insufficient suction.
- (5) The nozzle has solder paste or rubbish cause air leakage
- (6) The nozzle is damaged or cracked cause air leakage

12.3 Continuous SMT production

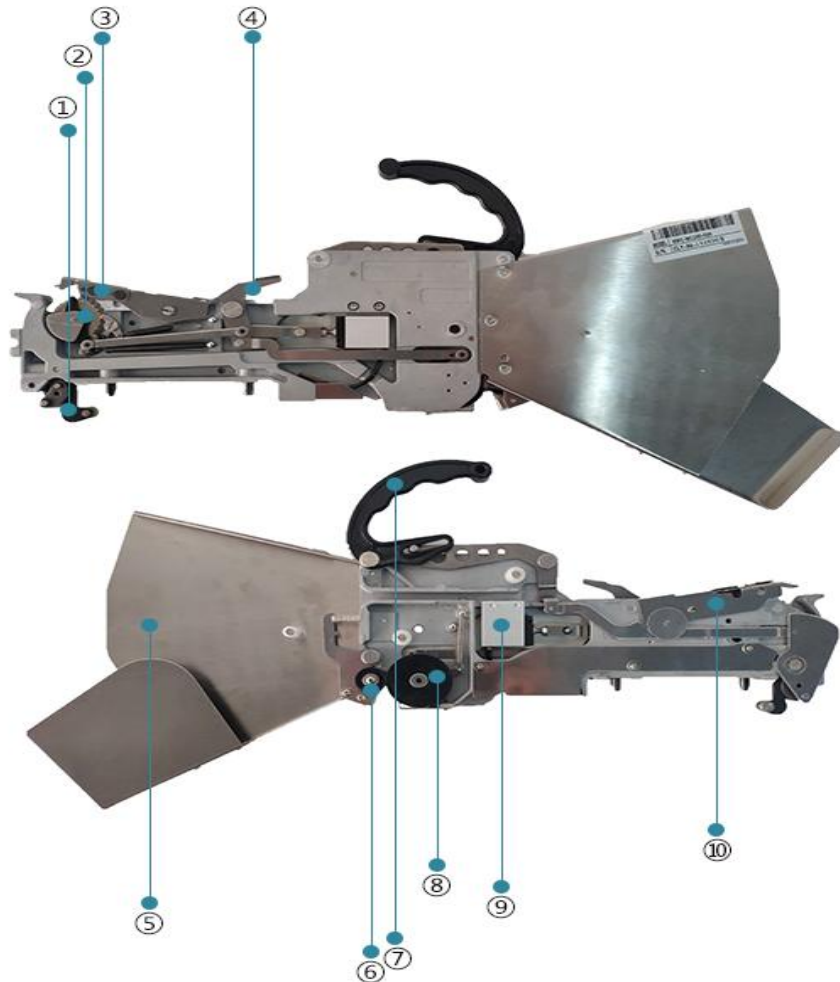
Follow the SOP to start production

Notes:

- (1) Do not touch the surface to board to avoid damaging the printed solder paste.
- (2) When the error message occurs, please check out and solve it a.s.a.p.
- (3) Once reloading the component during production, pay attention to the model, specification, polarity and direction of components.
- (4) Clear the reject box timely to avoid wasted materials stacked too high to damage the mount head

13. Structure and maintenance instruction

13.1 Feeder Brief Introduction



- | | |
|-------------------------------|----------------------|
| ① Front fixed buckle | ⑥ Single-track wheel |
| ② Material-sending wheel gear | ⑦ Hand Shank |
| ③ Press material cover | ⑧ Tape coiling wheel |
| ④ Locking Claw | ⑨ Cylinder |
| ⑤ Tail board | ⑩ Snap joint cover |

13.2 Installing Tape and Reel Components



Fig1



fig2

1. Making the feeder in open status to wait for installing the tape reel ①Lift up the feeder fixing handle; ②Press the material-sending handle with left hand ③meanwhile press the lamellule at right side of the feeder with your right hand; ④loosen the material-sending handle, ensure the proper wrapped (see figure 1) then loosen the lamellule.

2. Installing the tape and reel components: setting the reel on reel storage at the back side of the feeder, pull out approximately 10cm length tape, separate the film and tape, then put into transfer storage (see figure 1).The tape should be closely matched with the gear, and the film should pass through the upper denomination groove (see figure 2) through two white guide wheels and then be sandwiched between two gears.

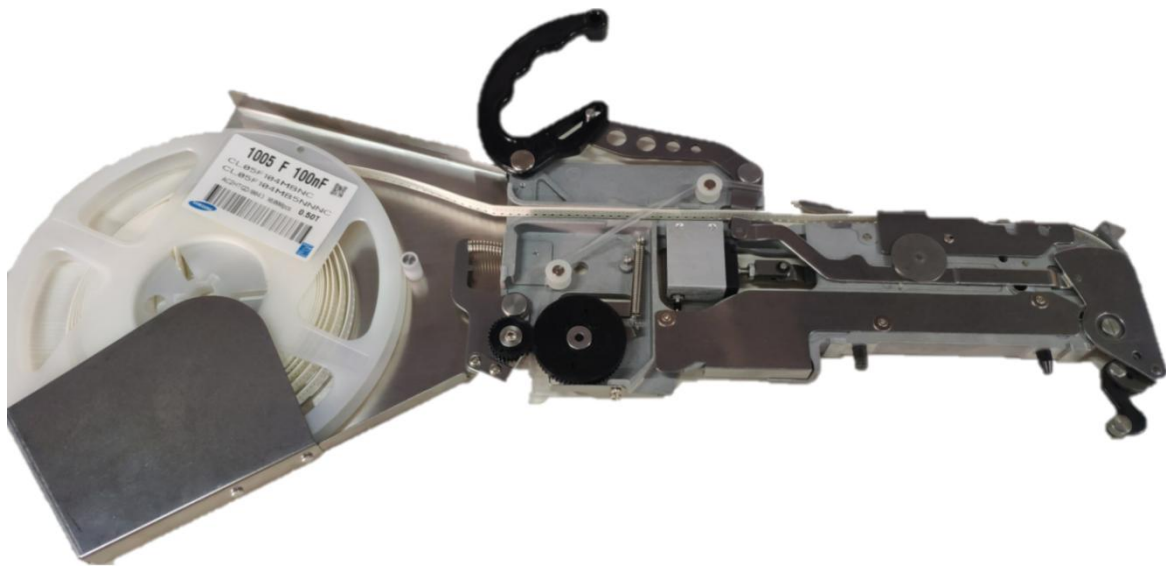


Fig3

3. Finish installing tape and reel components

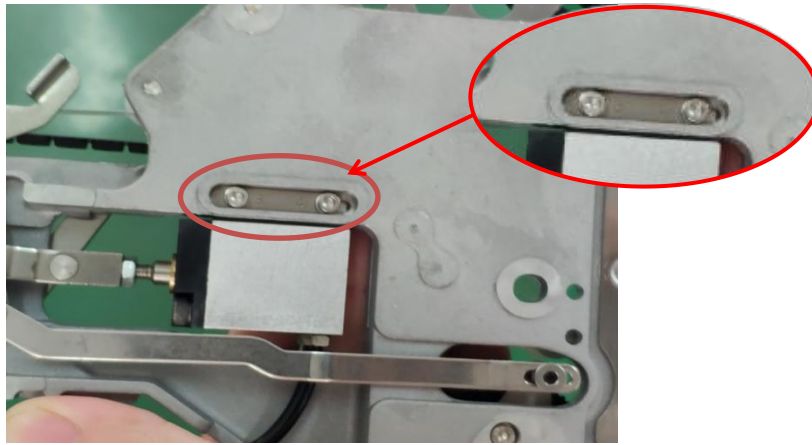


Fig4

For 12mm,16mm width feeder, the feed rate can be adjusted by adjusting the parameters of the feed regulator.

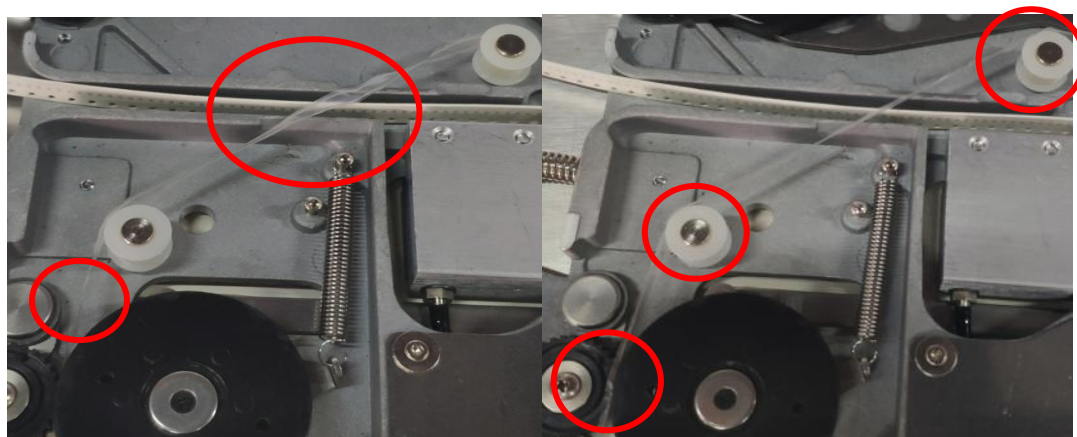
13.3 Incorrect Installation Samples:

1. Incorrect setting of reel in reel storage (see figure.5)



Fig5

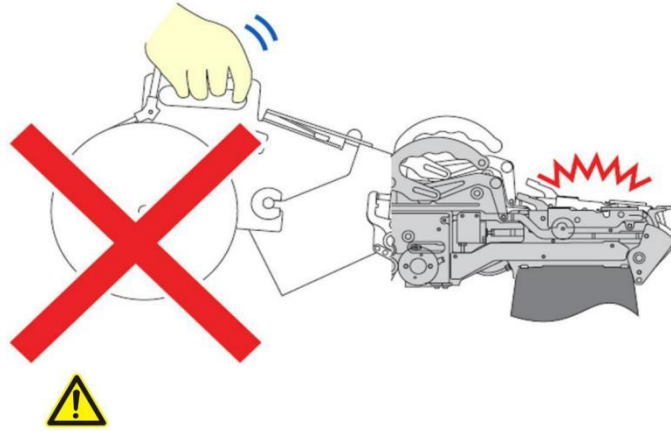
2. The film is twisted, not tight enough, or the film is not between the white guide wheel and the black gear.



3. Cautions: Strictly refer to the instruction manual to use the feeder, and non-standard operation is

strictly forbidden.

Warning: when installing the feeder, if feel the hand press is not strong, or loose match in place, then it is forbidden to operate. Otherwise will cause feeder floating in the operation and collision problem. In case of this situation, please contact the after-sales department of our company



Warning: when installing the feeder on the equipment, make sure there is no foreign matter on the feeder fixed plate, and make the bottom surface of the feeder fully fit with the fixed plate. The handle is the main way to lock the feeder, so pls pay attention to protect this part. (Note: Don't move the feeder while the equipment is running, or it may cause collision problem.)

13.4 Nozzle Information

The size of the nozzle

Please choose nozzles according to the shape and size of components.

Table1-1 Nozzle

Type	Regular	Regular	Regular	Regular	Regular	Regular	Regular	Regular
Model	CN030	CN040	CN065	CN100	CN140	CN220	CN400	CN750
Illustration								
External Diameter	0.6mm	0.8mm	1.0mm	1.8MM	2.0mm	3.6mm	5.0mm	9.0mm
Inner Diameter	0.3mm	0.4mm	0.7mm	1.0MM	1.4mm	2.2mm	4mm	7.5mm
Type	Special	Special	Special	Special	Special	Special	Special custom	
Model	YX01	YX02	YX03	YX04	YX05	YX06	-	
Illustration								
Shape								

The reference of nozzles selection

In order to ensure the placement accuracy, please select nozzles according to the shape and size of components.

Table 1-2 size comparison of Nozzles

Model	Recommendation (Imperial system)
CN030	0201
CN040	0402 (optimal)
CN065	0402、0603 etc.
CN100	0805、diode、1206、1210 etc.
CN140	1206、1210、1812、2010、SOT23、5050, etc.
CN220	SOP series ICs、SOT89、SOT223、SOT252, etc.
CN400	ICs from 5 to 12mm
CN750	ICs bigger than 12mm
YX01	3528series Soft bead
YX02	High power lamp beads
YX03	Chips and BGA from 11mm to 17mm BGA
YX04	Chips and BGA bigger than 17mm
YX05	4148 circular diode
YX06	3535 ball shape LED(Spherical height 1.4mm,overall height 1.9mm)

14. Maintenance

14.1 Routine Maintenance

14.1.1 Reinforce daily maintenance

P&P machine is that high-accuracy device which requires a clean working environment with constant temperature and humidity, so it's necessary to have a routine maintenance.

14.1.2 Requirements for operator

Operator should get a basic operator training, which should cover fully all the skills and knowledge needed to safely operate the type of pick and place machine.

Operating strictly against equipment's instruction. Don't use machine with problems. Stop the machine once malfunction appears and contact with the after-sales service staff, restart to work after problem solved.

Operator should be concentrated.

Observation-- to see whether there is abnormal situation, such as peel-box doesn't work, plastic tape is broken etc.

Listening-- whether have strange sound, such as noise from placement head, sound of loss component, strange noise of conveyor etc.

Handwork-- solve some small problems in time, such as install feeder, correction placement position etc. If the main machine body or circuit problem, please consult after-sales staff. Formulate measures to reduce/ avoid big problem.

14.1.3 Formulate the measures to reduce/avoid big problem

The most easily appeared problem during work are placement wrong components and placement misaligned. Supply below measures for ref.

- ①It needs to check whether the components package is matched with related feeder. If not, please correct them.
- ②As to tape reel feeder, when ran out of one reel, operator must check whether newly changed tape reel is correct or not.
- ③After import the SMD file or edit chip list manually, please recheck each components No., nozzle rotation angle and placement position to make sure correct.
- ④Operator must check the first finished PCB of each file. If any problem, please find solutions such as revise program to solve it.
- ⑤To check the placement position misaligned or not, component loss problem in regular work. Find reason in time and solve it.
- ⑥Set pre-welding detection station (manual or AOI)

In sum, P&P machine's running speed and placement accuracy still has limit. Peoples work is important to run machine on its proper role. So, it's necessary to comply with effective measures to keep machine normal work, its placement quality and efficiency.

14.2 Routine Inspection

Arrange regular inspection and maintenance system.

14.2.1 Daily Inspection

	Items
Items check before power on	<ul style="list-style-type: none"> ①Temperature& Moisture: Temperature 20°C~26°C, humidity 45~70% ②Indoor environment: Air clean without aggregate air. ③No clutters within the placement area and keep rails clean. ④No spots on cameras and keep lens clean. ⑤No obstacles around the head nozzles ⑥Checking if nozzles are dirty, distorted; If so, please clean or change the nozzle. ⑦Checking if feeders are correctly installed in stacks and confirm no clutters on stack. ⑧Checking the connection of air connector and air hose ⑨Checking air pressure.
Items check after power on	<ul style="list-style-type: none"> ①Checking if the monitor display normally after system start up. ②Checking if emergency button can work normally or not. ③Checking if placement head can move back to the origin. ④Checking if there's abnormal noise while placement head move. ⑤Checking all nozzles vacuum pressure. ⑥Checking if PCB moving on rails smoothly or not; Sensor workable or not. ⑦Checking if the board has been well fixed by magnetic bar and pins.

14.2.2 Monthly Inspection

Items	Detailed Inspection
X/Y axis	Make sure no abnormal noise while placement head moving.
X/Y motor	Make sure X/Y motors no overheating.
Nozzle	Checking if all nozzles are good without bend and nozzle surface is horizontal
Air hose	Checking the connection between air hose and machine, keep sure the hose in good situation without wearing or air leaking.
Step motor	Checking if any dirty on step motor, synchronous belt, Synchronous wheel. Make sure the Z-axis motor can up, down and rotate smoothly.
Z-axis motor	Checking if the placement head can go up and down smoothly. Use your finger to push the nozzle to check if it moves smoothly. Let each nozzle head up and down beyond the normal range.
Vacuum pressure	Checking all nozzles' vacuum pressure. If abnormal, please clean nozzles.
Positive pressure	Checking if the positive pressure normal.
Optical axis	Checking whether it is covered dusk. Please keep it clean and lubricated
Operation button	Checking each button to make sure they are well-worked
Connector	Checking if well-connected the air hose and air connector.

PCB clamp block	check their wear pattern
--------------------	--------------------------

14.3 Related Issues During Solder Paste Printing Process

14.3.1 Stencil Printing Technology

Screen printing technology refer to using ready-made stencil, directly connect to the printer in a certain way, make the solder paste evenly flow on the stencil and then leak into the mesh through the holes. When getting the stencil away, solder paste had been covered to the printed circuit board solder graphics, then finish the solder paste printing on the PCB.

14.3.2 Inspecting of solder paste printing

Printing process is one of the key working procedures to ensure the quality of surface mounting. According to the statistics, under the premise of guaranteed quality about components and PCB, correctly PCB design, 70% of the surface quality problem caused during printing process. In order to ensure the quality of SMT assembly, it is necessary to strictly control the quality of the solder paste printing.

The amount of solder paste printing requirements are as follows:

- (1)The using amount of solder paste should be uniform, good consistency. Solder paste graphics should be clear, try to avoid adhesion between adjacent graphics. Solder paste graphics and solder graphics should be consistent.
 - (2)In general, keep unit area amount of solder paste about 0.8 mg/mm². For fine pitch components, should be 0.5 mg/mm² (using stencil thickness and hole size to control in the actual operation).
 - (3)Printed on the substrate of solder paste compared with required value, a certain deviation is permissible, the covering area of the solder paste on each solder pad should be more than 75%.
 - (4)Should be no seriously collapsing problem and edges neatly after solder paste had been printed, the dislocation shouldn't be larger than 0.2 mm, for solder pad of fine pitch components, dislocation shouldn't be larger than 0.1MM, pollution by solder paste is not permitted to the PCB.
- Inspection by 2~5 times magnifier or 3~20 times microscope.

14.3.3 The defects of solder paste printing, reasons and solutions

Excellent printing graphics should be uniform in both vertical and horizontal direction, full, clean all round, solder paste fill solder pad. Using above such printing graphics device, after reflow soldering, will get good welding effect then.

Problem	Reason	Issue	Solution
Solder paste graphics dislocation	Holes on the stencil not good match with solder pad; No enough precision of the Printing machine	easily cause bridge connection	Adjust the stencil position; Adjust the printing machine
Solder paste graphics have icicles and dents	Scraper pressure is too large; Rubber scraper hardness is not enough; Holes are too big in the stencil	Solder paste required volume is not enough, easy to appear faulty soldering; solder joint strength is not enough.	Adjust the printing pressure; Use metal scraper; Improved holes designing in the stencil.
Too much solder paste	Holes are too big in the stencil; The gap is too big between stencil and PCB	easily cause bridge connection	Check the holes size in stencil; Adjust the parameters of printing, especially the gap between PCB and stencil
Graphic uneven (have breakpoints)	Holes' wall are not smoothness enough; not wipe residual solder paste in using for many times; Solder paste's thixotropy is bad	Easy cause no enough solder paste, lead to the problem such as faulty soldering.	Wipe the stencil
Contamination of the graphics	Not wipe residual solder paste in stencil after using for many times; Poor quality of solder paste; Shake problem when getting the stencil way	easily cause bridge connection	Wipe and clean stencil; replace solder paste; adjust the machine

Dear users, the above is NeoDenK1830 operation instructions, if you have any questions, feel free to contact us, we will be happy to serve you.

Thanks again for supporting NeoDen Tech.

Zhejiang NeoDen Technology Co., Ltd

Zhejiang Neoden Technology Co., Ltd